



THE
ULTIMATE
OUTBOARD MOTOR

SUZUKI MARINE OUTBOARD MOTORS

FULL LINE CATALOG



SUZUKI CLEAN OCEAN PROJECT

As the world's ULTIMATE OUTBOARD MOTOR brand, Suzuki always remains focused on providing the ultimate marine experience, which requires a healthy and clean marine environment.

Since 2010, we have been voluntarily conducting the "Clean-Up the World Campaign" every year to contribute to a better marine environment and more than 10,000 people have participated. In Japan, the campaign has been officially recognized by the Ministry of the Environment in the "Plastic Smart Campaign".

To continue to make our utmost effort for environmental protection, it is now time for us to review how we have been contributing to the environment and society and newly determine our direction. As well as continuing our worldwide clean-up campaign, we will also commit to take responsible actions against plastic waste problems. This is how we came to make the new Slogan and Logo, "SUZUKI CLEAN OCEAN PROJECT", to show the world our commitment.

Our Commitment

1. Clean-Up the World Campaign
2. Reduce Plastic Packaging
3. Collect Marine Micro-Plastic Waste



We believe the actions Team Suzuki takes around the world will be one positive step forward to a cleaner marine environment.

CONTENTS

- 4-5 **SUZUKI CLEAN OCEAN PROJECT**
- 6-7 **SUZUKI ULTIMATE TECHNOLOGY**
- 12-13 **DF350AMD / DF300BMD** NEW
- 14-15 **DRIVE BY WIRE SERIES**
- 16-17 **350-300HP FLAGSHIP-GEKI SERIES**
DF350AMD/300BMD,
DF350A/300B
- 18-19 **V6 300-200HP**
DF300AP/250AP
DF250/225
- 20-21 **IN-LINE 4 200-150HP**
DF200AP/175AP/150AP
DF200A/175A/150A
- 22-23 **IN-LINE 4 140-70HP**
DF140BG/115BG
DF140B/115B
DF90A/80A/75A
- 24-25 **IN-LINE 3 60-25HP**
DF60AV/50AV
DF60A/50A/40A
DF30A/25A
- 26-27 **PORTABLE 20-2.5HP**
DF20A/15A/9.9B
DF9.9A
DF6A/4A
DF2.5
- 28-29 **SS SERIES**
DF250SS
DF115BSS
DF200RSS
DF150SS
DF250ATSSW
- 30-33 **SPECIFICATIONS & FEATURES**
- 34-36 **PARTS & ACCESSORIES**
- 37 **ECSTAR/SYNCRO EYE**
- 38-39 **HISTORY**

SUZUKI CLEAN

OCEAN PROJECT

1. CLEAN-UP THE WORLD CAMPAIGN



More than 10,000 people from 53 Suzuki distributors participated in this activity.
*As of December 2021.

2. REDUCE PLASTIC PACKAGING

In order to avoid producing additional plastics, we have been replacing the plastic packaging of outboards and marine genuine parts to eco-conscious materials.

Packaging for Suzuki marine genuine parts



■ Oct. 2020 - Mar. 2022 : Reduced **6.4 tons**.
Replacing the plastic packaging to Paper.



■ Sep. 2021 - Mar. 2022 : Reduced **4.8 tons**.
① Outer Carton Fixing (Polyethylene → Paper)
② Body Cover (Polyethylene → Biodegradable Material)
③ Engine Cover (Nylon → Rayon)

3. COLLECT MARINE MICRO-PLASTIC WASTE

How can Suzuki use its products to reduce marine micro-plastic waste?

Are there any ways to tackle the problem without sacrificing the performance of the engine or harming the environment?

As a solution to this challenge we came up with the **Micro-Plastic Collecting Device (MPC)**.



STANDARD EQUIPMENT FROM JULY 2022 PRODUCTION. (FOR MODEL YEAR)

FEATURES



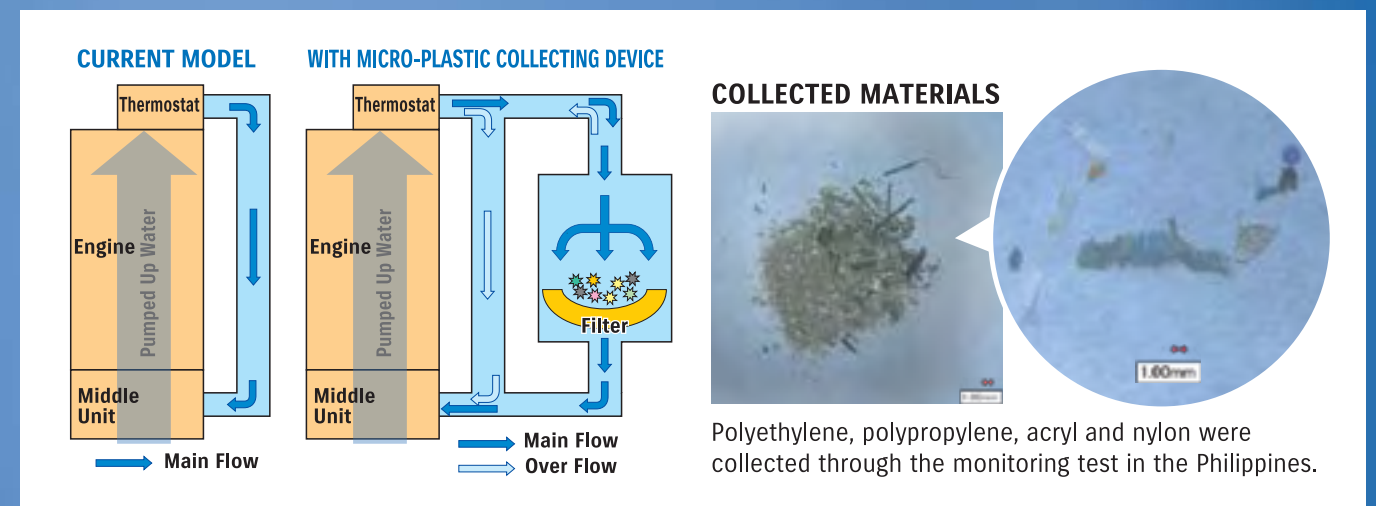



























- Easily maintained
- This MPC device does not affect the performance of the engine even if the filter gets clogged due to the design of the bypass.



The MPC is available now! Starting in July of 2022, the MPC is standard equipment on the DF140BG/115BG, DF140B/115B. We believe our small actions will lead to a larger impact to positively change the current situation of the marine environment. We look forward to your support through the participation in the **CLEAN-UP THE WORLD CAMPAIGN** and the use of the MPC.

LEADING THE INDUSTRY WITH AWARD WINNING TECHNOLOGIES AND DESIGNS, SUZUKI OUTBOARDS PROVIDE FEATURES AND BENEFITS THAT MAKE BOATING EVEN MORE ENJOYABLE

THE ULTIMATE OUTBOARD MOTOR

Durability & Reliability	Performance	Ease & Comfort	Ecology & Economy
<ul style="list-style-type: none"> • Durable • Notifies user before engine trouble • Easy to service, repair         	<ul style="list-style-type: none"> • Smooth and quick acceleration at all operating ranges • Powerful torque       	<ul style="list-style-type: none"> • Less vibration • Quiet operation • Light & Compact • Easy to use • Smooth and Decisive shifting          	<ul style="list-style-type: none"> • Good fuel efficiency / low exhaust emissions • Low maintenance cost • Environmental protection activities    

NMMA Innovation Awards

The Innovation Awards (recognizing technological innovation) granted each year by the NMMA (National Marine Manufacturers Association) are considered among the highest honors in marine technology. Of the new marine industry products in that year, they are awarded to "a product that shows technical leadership, is practical and cost-effective, and is truly beneficial to the consumer."

Starting with the DT200 Exanté in 1987 and extending to the DF350A in 2017, Suzuki outboard motors have received this Innovation Award a total of nine times. Eight of these awards are for 4-stroke outboard motors.



Awarded Prizes

1987: DT200 Exanté	2011: DF50A & DF40A
1997: DF70 & DF60	2012: DF300AP
1998: DF50 & DF40	2014: DF30A & DF25A
2003: DF250	2017: DF350A
2006: DF300	

Durability & Reliability



SUZUKI DUAL LOUVER SYSTEM

▶DF350AMD/300BMD ▶DF350A/300B

Dog-leg shaped dual louvers remove water from the air taken into the cowling.

ADVANTAGE

- Prevents water intrusion.
- Allows a direct intake system, contributing to higher engine output.



SELF-ADJUSTING TIMING CHAIN

▶DF40A AND UP

The timing chain running in an oil-bath can be adjusted automatically by hydraulic tensioner.

ADVANTAGE

- More durable than the belt type.
- Maintenance-free.



DUAL WATER INLET

▶DF350AMD/300BMD ▶DF350A/300B
▶DF300AP/250AP ▶DF250ATSSW ▶DF250SS

The engine's cooling system relies on water supplied through two water inlets located on the lower unit.

ADVANTAGE

- Increases the water flow, providing better cooling performance.



WATER DETECTING SYSTEM

▶DF75A AND UP

A water detecting fuel filter prevents water intrusion. When water is detected, the system will alert the driver with visual and audio warnings.

ADVANTAGE

- Prevents lower power output and corrosion by avoiding water intrusion.



TILT LIMIT SYSTEM

▶DF50AV AND UP
(not including DF50A/40A)

Tilt Limit System prevents the outboard from tilting beyond a selected angle.

ADVANTAGE

- Prevents damage to the boat or outboard due to excessive outboard tilting.

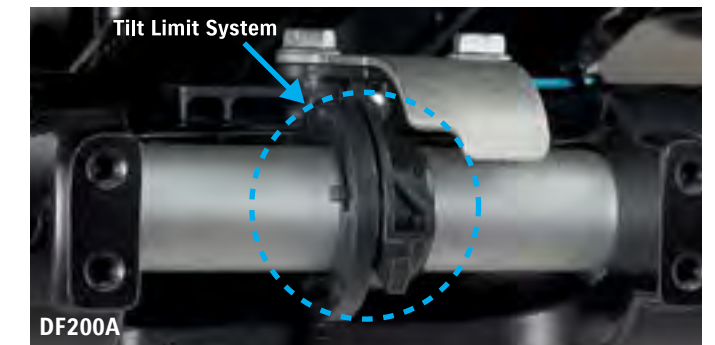

SUB WATER INLET

OPTIONAL: ▶DF140BG/115BG ▶DF140B/115B
STANDARD: ▶DF60A/50A/40A

Two water inlets in different directions ensure that the engine does not overheat due to clogging by sea grass or algae.



KEYLESS START SYSTEM

OPTIONAL: ▶DF350AMD/300BMD ▶DF350A/300B
▶DF300AP/250AP ▶DF250ATSSW
▶DF200AP/175AP/150AP ▶DF200A/175A/150A
▶DF140BG/115BG ▶DF140B/115B
▶DF90A/75A

This system allows you to start multiple engines by placing a key-fob nearby.

- One push Start & Stop for up to 6 outboard motors.
- Waterproof Float Key Fob.
- Security support with immobilizer.

ADVANTAGE

- Provides high security.
- No ignition key is necessary.



SUZUKI ANTI-CORROSION FINISH

▶ALL MODELS

Special protection is applied to the aluminum surface using high strength bonding to protect the aluminum made exterior parts.

ADVANTAGE

- Protection against corrosion helps increase the overall outboard durability.

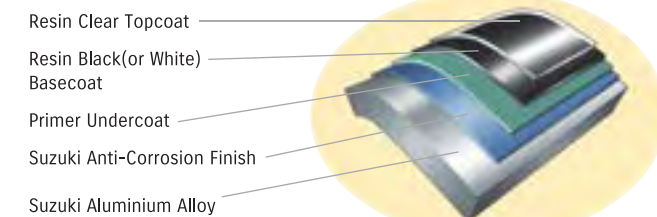

NEW SDSM+ (SUZUKI DIAGNOSTIC SYSTEM MOBILE+)

▶DF9.9B AND UP*

Use the app to plan for boating by checking the weather forecast, the engine condition and operation tips. All functions are available for free.* Please check our website and page 34 for more details.

*SMD/SMG4 and a smartphone running Android/iOS are required.

ADVANTAGE

- Possible to make a plan for boat trip with checking the weather forecast in advance.
- Check up on the engines before the departure based on the engine data.
- Acquire the engine data by scanning the QR code*.
- Provide the engine data to dealer and ask for maintenance easily.

*DENSO WAVE owns the rights of the name and the logo of QR code.

Performance



OFFSET DRIVESHAFT

▶DF75A AND UP

The engine powerhead is positioned closer to the front, moving the outboard's center of gravity forward.

ADVANTAGE

- Less vibration
- More compact
- Stable steering performance

1st Stage Reduction : 30:36=1.20
2nd Stage Reduction : 12:25=2.08
Total : 2.50:1

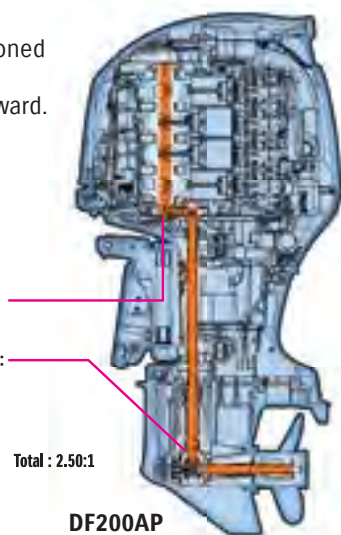

2-STAGE GEAR REDUCTION

▶DF75A AND UP

This design makes a lower gear ratio possible, allowing it to turn a larger diameter higher pitch propeller.

ADVANTAGE

- Increased power to turn large diameter propellers, offering quick acceleration.
- High propulsive efficiency with large diameter propeller.
- Powerful navigation, maintaining propeller rotation even with a larger load.

GEAR RATIO IN EACH CLASS

MODEL	DF140BG/115BG DF140B/115B 90A/80A/75A	DF200A(AP)/ 175A(AP)/150A(AP)	DF250/ 225	DF300AP/ 250ATSSW	DF350AMD/ 300BMD DF350A/300B
GEAR RATIO	2:59:1	2:50:1	2:29:1	2:08:1	2:29:1



HIGH ENERGY ROTATION

▶DF60AV/50AV

Larger lower units (2.42 gear ratio) make it possible to equip larger 36cm (14-inch) propeller than other models in this class. It offers good acceleration and large power.

ADVANTAGE

- Powerful torque to carry heavy loads.
- Quick acceleration with larger propellers.
- Quick and smooth planing.

DF60AV vs. DF60A size comparison

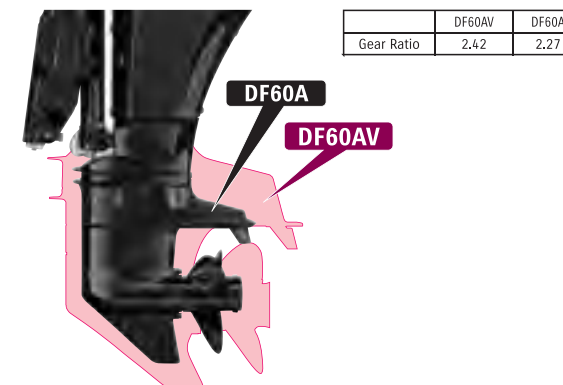

VVT (Variable Valve Timing)

▶DF350AMD/300BMD ▶DF350A/300B
▶DF300AP/250AP ▶DF250SS ▶DF250ATSSW
▶DF200AP/175AP/150AP ▶DF200A/175A

The Variable Valve Timing controls the opening and closing timing of the intake valve depending on the engine RPM.

ADVANTAGE

- Offers smooth, powerful torque.
- Provide smooth acceleration across all speed ranges.

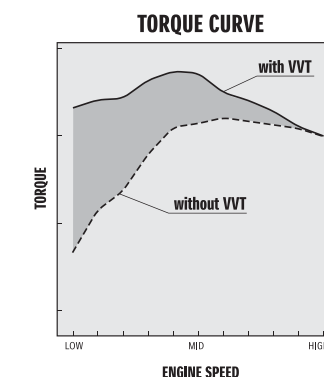

MULTI-STAGE INDUCTION

▶DF250/225 ▶DF200AP/175AP/150AP
▶DF200A/175A/150A ▶DF250ATSSW

Manifold pipes are switched between short and long during low speed and high speed operation to ensure the right volume of air enters the engine.

ADVANTAGE

- Increases output during high speed operation with greater volume of air input.
- Increases combustion efficiency and maximizes torque during low speed operation.

AIR FLOW IN MULTI-STAGE INDUCTION MODULE

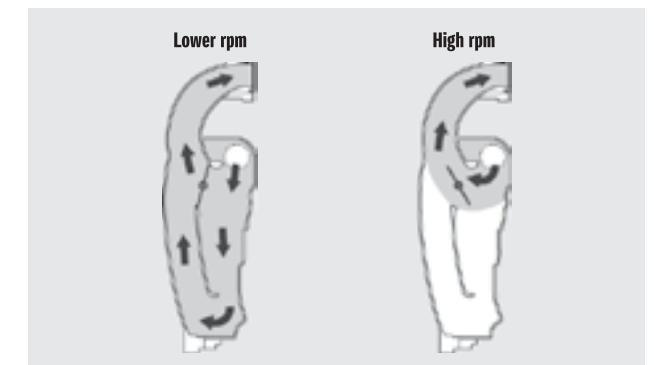

DIRECT AIR INTAKE

▶DF350AMD/300BMD ▶DF350A/300B

A direct airflow path from the intake port to the cylinder suppresses temperature rise of the air and improves combustion efficiency.

ADVANTAGE

- Delivers higher power output from a small displacement.



SUZUKI DUAL PROP SYSTEM

▶DF350AMD/300BMD ▶DF350A/300B

The Suzuki Dual Prop System spins two propellers rotating in opposite directions on a single engine. With the 6 blades, it can get a better grip on the water.

ADVANTAGE

- Achieve superior stability when driving straight.
- Powerful reverse thrust and braking force.
- Good water gripping performance and quick startup acceleration.

Ease & Comfort



SUZUKI SELECTIVE ROTATION

▶DF300AP/250AP ▶DF200AP/175AP/150AP

Function for selecting regular or counter rotation on one outboard with an optional connector and a counter rotation propeller.

ADVANTAGE

- Either regular or counter rotation can be used on the same outboard.



THREE-WAY STORAGE

▶DF6A/4A

The design allows the outboard to be removed from the boat and placed on any of its 3 sides for storage.

ADVANTAGE

- No need to worry about the loading space or method.



SUZUKI PRECISION CONTROL (Electronic Throttle and Shift Systems)

▶DF350AMD/300BMD ▶DF350A/300B ▶DF300AP/250AP
▶DF250ATSSW ▶DF200AP/175AP/150AP ▶DF140BG/115BG

Operation from the remote control is delivered to the outboard via an electric signal and it enables the 1 lever operation for up to 6 outboard motors (for dual mount only).

ADVANTAGE

- Less friction and resistance compared to the mechanical ones.
- Easy control for multiple outboard motors.
- Improved fuel economy with the combination of Lean Burn Control System.



OVERHEAD TANK

▶DF6A/4A

The integral overhead fuel tank and one-way valve delivers fuel supply by using gravity.

ADVANTAGE

- Contributes to easy start.

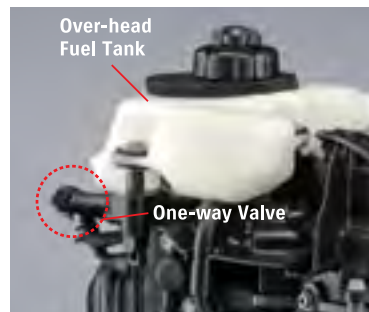

NOISE REDUCTION

▶DF350AMD/300BMD ▶DF350A/300B
▶DF200AP/175AP/150AP ▶DF200A/175A/150A
▶DF140BG/115BG ▶DF140B/115B

Intake noise is suppressed with silencer and resonator.

ADVANTAGE

- Less noise, makes boating more pleasant.

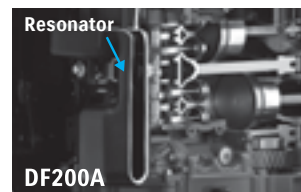

AUTOMATIC TRIM*

▶DF350AMD/300BMD ▶DF350A/300B ▶DF300AP/250AP
▶DF200AP/175AP/150AP ▶DF250ATSSW
▶DF200A/175A/150A ▶DF140BG/115BG ▶DF140B/115B

The Automatic Trim adjust trim angle automatically depending on the engine RPM without your control.

ADVANTAGE

- Helps to keep the appropriate trim angle and contribute to achieve faster top speed and better fuel efficiency.

*Available with SMD / SMG4



SUZUKI TROLL MODE SYSTEM*

▶DF40A AND UP
Optional for Remote Control Models
(not including DF250/225/200, DF90AWQH)

This system helps the boat running at a certain speed range in low RPM.

ADVANTAGE

- Boat can keep running at a certain speed range in low RPM without having to operate the throttle on the boat.
- Gives you highly precise control at low RPM.

*Available with SMD, SMG4, or Troll Mode Switch Panel



SUZUKI EASY START SYSTEM

▶DF40A AND UP (not including DF250/225/200, DF250ATSSW)

Simply turn the key and release, and the starter stays engaged until the engine starts. This system offers a smoother start of the engine.



NEW Integrated Steering System

▶DF350AMD/300BMD

The conventional external hydraulic cylinder is built into the outboard motor.

ADVANTAGE

- Simple appearance of the motorwell when rigging.
- Allows rigging to various types of boats.
- Easy rigging.

Ecology & Economy



BATTERY-LESS ELECTRONIC FUEL INJECTION

▶DF30A/25A ▶DF20A/15A/9.9B

This technology delivers quicker start, smoother operation, and more acceleration without a battery.

ADVANTAGE

- Operates without battery.
- Quick and easy start.
- Cleaner and economic fuel consumption.
- Higher and smoother performance in almost all operating ranges.



DUAL INJECTOR

▶DF350AMD/300BMD ▶DF350A/300B

The dual injectors deliver just the right amount of fuel at the right time into each cylinder.

ADVANTAGE

- Contributes to higher output and better fuel efficiency.



LEAN BURN CONTROL SYSTEM

LEAN BURN

▶DF9.9B AND UP
(not including DF250/225/200, DF250W, DF250ATSSW)

The Lean Burn Control System supplies the appropriate amount of fuel and air mixture depending on the navigation conditions.

ADVANTAGE

- Significant improvement in fuel economy in all speed ranges especially at cruising speed.
- Fuel is saved and gasoline costs are lowered.

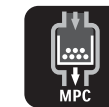

NEW Micro-Plastic Collecting Device

▶DF140BG/115BG ▶DF140B/115B

As one of the actions in SUZUKI CLEAN OCEAN PROJECT, we developed the device to collect micro-plastics in the oceans just by running SUZUKI's outboard motors.

ADVANTAGE

- Collect micro-plastics through your outboard motors.
- Not sacrifice the engine performance.

NEW DF350AMD / DF300BMD

- Suzuki's First Integrated Steering System
- Advanced New Gear Case
- Available in 20 inch(L), 25 inch(X) and 30 inch(XX) transom height.

Integrated Steering System

- Simple appearance of the motorwell when rigging.
- Allows rigging to various types of boats.

There is no need to worry about interference between the external cylinder and the boat.



Advanced New Gear Case

- Top Speed is increased more than 2%* by reducing 4% of the frontal projected area.

*The data is based on "In-House Suzuki Testing" under uniformed conditions. Results will vary depending upon operating conditions (boat design, size, weight, weather, etc).

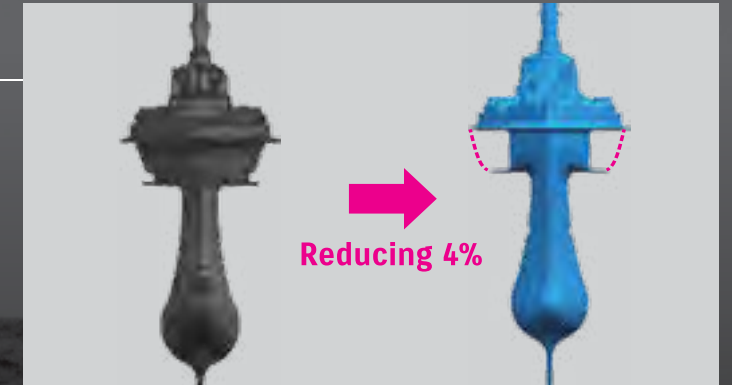

Conventional Gear Case vs Advanced New Gear Case

Advanced New Gear Case	Faster: 2% or more
Conventional Gear Case	

- Enhanced Durability & Reliability by lowering the gear oil temperature.
- The amount of gear oil was reduced from 3.2ℓ to 2.8ℓ.
- Available to change the gear oil by using the oil changer without lifting the boat.
- Compatible with conventional models.



Drive By Wire Series

Taking your boating experience to a new level for your ULTIMATE marine life

Drive By Wire (Suzuki Precision Control : S.P.C.) is a technologically advanced computer-based control system with electronic wiring that eliminates the source of friction and resistance. While you enjoy smooth throttle and shift operation, the system's computer is processing and transmitting commands in real-time to actuators at the engine that deliver precise throttle controls with smoother, decisive shifting.



Smooth Shift Operation

THE ULTIMATE OUTBOARD MOTOR



Easy Rigging



Luxury Remote Control

Remote Control Box Dual Top Mount



Fuel Efficient

Exclusive Option

FURUNO

NEW FishHunter™ Drive

FishHunter™ Drive delivers all-new control features for boaters utilizing select Suzuki outboard models driven by the Furuno NAVpilot-300 Autopilot. These new features offer enhanced autopilot controls for precision navigation of routes and advanced fishing features for anglers while jigging, or trolling.

Applicable Models : All SPC models (DF350AMD/300BMD, DF350A/325A/300B, DF300AP/250AP, DF200AP/175AP/DF150AP, DF140BG/115BG)



NAVpilot
NAVpilot-300



Speed Control

The boat will maintain a preset speed by adjusting engine RPM.



Point Lock™

Allows the vessel to easily keep a fixed position by controlling the steering and shift, canceling the effects of wind and current.



Route Smoothing™

Automatically controls the speed at waypoints for smooth turns while navigating a designated route. On approach to the final waypoint, the boat will slow down and activate Point Lock™ automatically to hold on the destination.



SABIKI™ Lock

Expands upon the NAVpilot-300's SABIKI™ function by controlling both the steering and throttle to maintain stern direction, freeing the angler to focus 100% on jigging and other vertical fishing.

SPECIFICATIONS / FEATURES P30-P33

V6 350-300HP Flagship-GEKI Series

◆ Drive By Wire DF350AMD / DF300BMD, DF350A / DF300B

THE
ULTIMATE
OUTBOARD MOTOR



SUZUKI DUAL LOUVER SYSTEM

Dual Louver system is designed to remove water from the air taken into the cowl.

Incorporating a direct intake system makes the highest compression ratio of 12.0:1(DF350AMD,DF350A), 10.5:1(DF300BMD, 300B) possible, ultimately leading to a higher engine output.

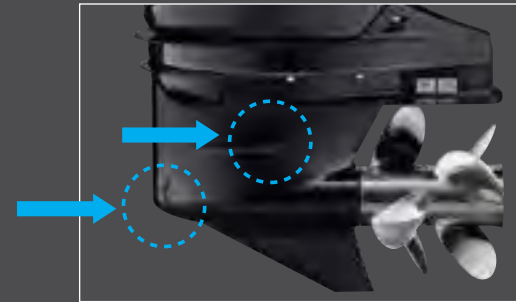

DUAL WATER INLET

The engine's cooling system relies on water supplied through low water intakes located on the lower unit. This dual water inlet configuration increases water flow into the lower unit, delivering greater cooling efficiency.



SUZUKI DUAL PROP SYSTEM

The dual prop system efficiently transmits the horsepower into propulsion. As an added benefit, because each propeller rotates in a different direction, exceptional stability is achieved.

In addition, the contra-rotating propellers produce a strong reverse thrust.



DUAL INJECTOR

Dual injectors deliver just the right amount of fuel at just the right time into the cylinder.

This dual injector contributes to higher output and better fuel efficiency.



DRIVE BY WIRE



DF350AMD

DF300BMD

DF350AMD/ DF300BMD



DF350A

DF300B

DF350A/ DF300B



GEKI: PARTING SEAS

A Force to Match the Power of Nature and the Sea Representing Suzuki's Identity and Heritage. A Symbol of Our Passion and Commitment to the Ultimate in Marine Innovation.

* "GEKI: PARTING SEAS" is the logo that represents the DF350AMD/DF300BMD, DF350A/DF300B

Durability & Reliability



Ecology & Economy

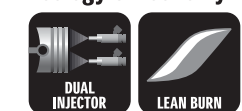

Performance



Ease & Comfort

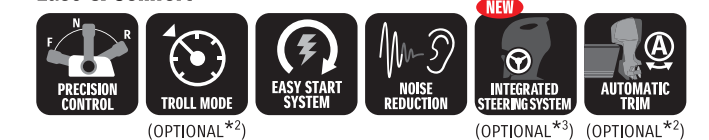

*1 Available with SMD or SMG4

*2 Available with SMD, SMG4, or Troll Mode Switch Panel

*3 DF350AMD/300BMD

SPECIFICATIONS / FEATURES P30

V6 300-225HP

- ◆ Drive By Wire DF300AP / DF250AP
- ◆ Mechanical DF250 / DF225

THE **ULTIMATE**
OUTBOARD MOTOR

Increased Alternator Output at Low Speed

Ideal for today's power-hungry fishing boats that spend a lot of time trolling

Applicable models : All V6 models (from 21 model year)

ADVANTAGE

- Increased alternator output at idle and low speed.
- Enables the use of more electric pumps and equipment.

At Idling Speed (650rpm) 23A → 33A **143%**

At 1,000rpm 38A → 43A **113%**



DF300AP
DF250AP

DRIVE BY WIRE



DF250
DF225

MECHANICAL

STANDARD FEATURES

Durability & Reliability

ANTI CORROSION ALL MODELS	SELF-ADJUSTING TIMING CHAIN ALL MODELS	WATER DETECTING SYSTEM ALL MODELS	TILT LIMIT ALL MODELS	SDSM+ (OPTIONAL*1) ALL MODELS
------------------------------	---	--------------------------------------	--------------------------	-------------------------------------

Performance

2.29 GEAR RATIO DF250 DF225 DF200	2.08 GEAR RATIO DF300AP DF250AP	OFFSET DRIVESHAFT ALL MODELS	VVT VARIABLE VALVE TIMING DF300AP DF250AP DF250	MULTI-STAGE INDUCTION DF250
---	--	---------------------------------	---	--------------------------------

ADDITIONAL FEATURES FOR DRIVE BY WIRE MODEL

Durability & Reliability

DUAL WATER INLET DF300AP DF250AP	KEYLESS START SYSTEM (OPTIONAL) DF300AP DF250AP
--	--

Ease & Comfort

SELECTIVE ROTATION DF300AP DF250AP	PRECISION CONTROL DF300AP DF250AP	TROLL MODE (OPTIONAL*2) DF300AP DF250AP	EASY START SYSTEM DF300AP DF250AP	AUTOMATIC TRIM (OPTIONAL*2) DF300AP DF250AP
--	---	--	---	--

Ecology & Economy

LEAN BURN DF300AP DF250AP

*1 Available with SMD or SMG *2 Available with SMD, SMG, or Troll Mode Switch Panel

SPECIFICATIONS / FEATURES P30

IN-LINE 4 200-150HP

- ◆ Drive By Wire DF200AP / DF175AP / DF150AP
- ◆ Mechanical DF200A / DF175A / DF150A

THE
ULTIMATE
OUTBOARD MOTOR

NEW SUZUKI PRECISION CONTROL (S.P.C.)

FEATURES

Operation from the remote control is delivered to the outboard motor via an electric signal and it enables the one lever operation for up to 6 outboard motors (for dual mount only).



SUZUKI SELECTIVE ROTATION

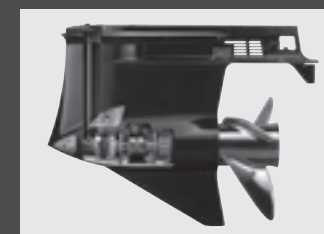

Function for selecting standard or counter rotation on one outboard with an optional connector.

NOISE REDUCTION

Intake noise is suppressed with a resonator, that reduces sound levels and improves the boating experience.



DF200AP
DF175AP/DF150AP

DRIVE BY WIRE

DF200A
DF175A/DF150A

MECHANICAL

STANDARD FEATURES

Durability & Reliability

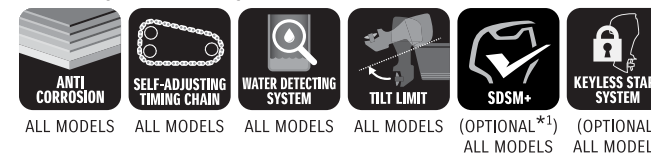

Ease & Comfort

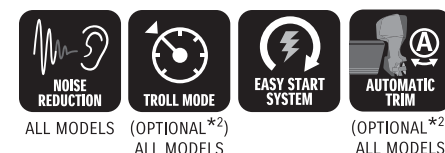

Ecology & Economy



Performance



ADDITIONAL FEATURES FOR DRIVE BY WIRE MODEL

Ease & Comfort

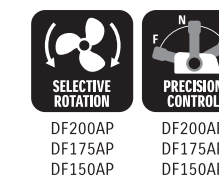

*1 Available with SMD or SMG4 *2 Available with SMD, SMG4, or Troll Mode Switch Panel

IN-LINE 4 140-70HP

- ◆ Drive By Wire DF140BG / DF115BG
- ◆ Mechanical DF140B / DF115B / DF90A / DF75A

THE
ULTIMATE
OUTBOARD MOTOR



**DF140BG
DF115BG**

DRIVE BY WIRE

with MPC

**DF140B
DF115B**

MECHANICAL

with MPC

**DF90A
DF75A**

MECHANICAL

■ Tiller handle model available (For 90HP & 75HP)

SUZUKI DF140B/DF115B

All New Design & Advanced Features For More Boaters

These models boast an upgraded 10.6:1 compression ratio that improves thermal efficiency for better acceleration and top-end speed. The redesigned cowl incorporates an air intake that keeps water out and features a silencer-resonator system to reduce engine noise in the cockpit.

The design also lets boaters replace the oil filter just by removing the upper engine cover, while an oil spill catcher helps prevent messes. A Water Detection fuel filter also helps protect these engines from contaminated fuel.

The optional SPC models are the first 4-stroke outboards in their size class to offer factory electronic controls for silky smooth shifting, instant throttle response, enhanced performance and better fuel economy.

A powerful 40-amp alternator delivers enhanced charging performance at low idle speeds, to help keep electronics, lights and equipment humming. Add all these features up, and you have a powerful choice for a wide range of fishing boats, large RIBs, pontoons and more.

2-STAGE GEAR REDUCTION

P8

This design makes a lower gear ratio possible, allowing it to turn a larger diameter higher pitch propeller.

MAINTENANCE KITS

P35



Suzuki provides Maintenance Kits for reliable service. Each Kit comes with all the maintenance parts necessary for your model.

Please ask your local Suzuki dealer for the contents of each kit and applicable models.

MULTI-FUNCTION TILLER HANDLE

P36



Suzuki's ergonomically designed tiller handle provides comfortable operation of the outboard with the left or right hand.

STANDARD FEATURES

Durability & Reliability



ANTI CORROSION
ALL MODELS



SELF-ADJUSTING TIMING CHAIN
ALL MODELS



WATER DETECTING SYSTEM
ALL MODELS



TILT LIMIT
ALL MODELS



SDSM+
(OPTIONAL*)
ALL MODELS



SUB WATER INLET
(OPTIONAL)
DF140BG/DF115BG
DF140B/DF115B



KEYLESS START SYSTEM
(OPTIONAL)
ALL MODELS



OFFSET DRIVESHAFT
ALL MODELS



2.59 GEAR RATIO
ALL MODELS

Performance

Ease & Comfort



(OPTIONAL*)
REMOTE CONTROL MODELS
(STANDARD)
TILLER HANDLE MODELS



EASY START SYSTEM
ALL MODELS



NOISE REDUCTION
DF140BG/DF115BG
DF140B/DF115B



AUTOMATIC TRIM
(OPTIONAL*)
DF140BG/115BG,
DF140B/115B

Ecology & Economy



LEAN BURN
ALL MODELS



MPC
DF140BG/DF115BG
DF140B/DF115B
DF100C

Ease & Comfort



PRECISION CONTROL
DF140BG
DF115BG

ADDITIONAL FEATURES FOR DRIVE BY WIRE MODEL

*1 Available with SMD or SMG4

*2 Available with SMD, SMG4, or Troll Mode Switch Panel

SPECIFICATIONS / FEATURES P32

IN-LINE 3 60-25HP

DF60AV / DF50AV
DF60A / DF50A / DF40A
DF30A / DF25A

THE
ULTIMATE
OUTBOARD MOTOR



DF60AV
DF50AV
HIGH ENERGY ROTATION
■ Tiller handle model available

DF60A
DF50A
DF40A
■ Tiller handle model & gas assist model available



STANDARD FEATURES

Durability & Reliability

- ANTI CORROSION**
ALL MODELS
- TILT LIMIT**
ALL MODELS
- SELF-ADJUSTING TIMING CHAIN**
ALL MODELS
- SUB WATER INLET**
DF60A
DF50A
DF40A

SUZUKI
SDSM
(OPTIONAL *1)
ALL MODELS

Performance Ease & Comfort

- HIGH ENERGY ROTATION**
DF60AV
DF50AV
- TROLL MODE**
(OPTIONAL *2)
ALL MODELS
- EASY START SYSTEM**
ALL MODELS

Ecology & Economy
LEAN BURN
ALL MODELS

*1 Available with SMD or SMG4
*2 Available with SMD, SMG4, or Troll Mode Switch Panel

DF30A
DF25A
BATTERY-LESS EFI
■ Gas assist model available
■ Remote Control model available



STANDARD FEATURES

Durability & Reliability

- ANTI CORROSION**
- SDSM+**
(OPTIONAL *1)
ALL MODELS

Ecology & Economy

- LEAN BURN**
- LESS BATTERY-LESS FUEL INJECTION**

*1 Available with SMD or SMG4



HIGH ENERGY ROTATION

These outboards are equipped with a 2.42 gear ratio, which is larger than the standard model, in their lower units. When combined with a large 36cm (14-inch) propeller, the system can deliver powerful thrust. This is ideal for heavy boats.

ADVANTAGE

- Powerful propulsion and precise maneuvering even with heavy loads.
- Superior power to turn large diameter propellers.

DF60AV vs. DF60A size comparison

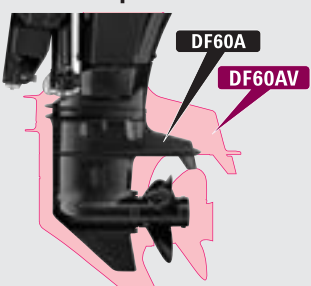

	DF60AV	DF60A
Gear Ratio	2.42	2.27



SELF-ADJUSTING TIMING CHAIN

The timing chain running in an oil-bath is adjusted automatically by an automatic hydraulic tensioner.

ADVANTAGE

- More durable than the belt type.
- Maintenance-free.



BATTERY-LESS Electric Fuel Injection

P11

This technology delivers quick start, smooth operation, and strong acceleration without a battery.

TROLL MODE + SMG4

P33



Allows you to control your troll mode from the Multi-Function Gauge.

PORTABLE 20-2.5HP

DF20A / DF15A / DF9.9B
 DF9.9A
 DF6A / DF4A
 DF2.5



**DF20A
 DF15A
 DF9.9B**

BATTERY-LESS EFI

■ Remote control mode available

**DF6A
 DF4A**

THREE-WAY STORAGE

DF2.5

THE
ULTIMATE
 OUTBOARD MOTOR



INTEGRAL OVERHEAD FUEL TANK

The integral overhead fuel tank and one-way valve delivers fuel supply using gravity.

THREE-WAY STORAGE



The design allows the outboard to be removed from the boat and placed on any of its 3 sides for storage.

STANDARD FEATURES

Durability & Reliability



ALL MODELS (OPTIONAL *1)
 DF20A
 DF15A
 DF9.9B

Ease & Comfort



DF6A DF4A
 DF6A DF4A

Ecology & Economy



DF20A DF20A
 DF15A DF15A
 DF9.9B DF9.9B

*1 Available with SMD or SMG4

SS SERIES OUTBOARD MOTORS

DF250ATSSW / DF250SS / DF200SS / DF150SS / DF115BSS

MECHANICAL

The current mechanical series “SS” series offers the DF250SS, DF200RSS, DF150SS and the DF115BSS. All these models take advantage of Suzuki’s “Big Block” displacement, offset driveshaft layout with 2-stage gear reduction, and multi-point sequential electronic fuel injection. The exclusive SS Trim Package, matte black paint job and striking cowling graphics are a perfect match to the performance of these proven engines.



DF250SS

STANDARD FEATURES



DF200RSS DF150SS

STANDARD FEATURES



DF115BSS

STANDARD FEATURES



DIGITAL

NEW

New for 2023, This new Digital SS engine offers the latest technology to include Suzuki Precision Control drive-by-wire for instantaneous acceleration that integrates with Suzuki’s Digital Pro-Pedal Foot Throttle. The new DF250ATSS, available only in white includes a new revised cowling design that features additional louvers, upper cover grips and new updated “SS” Matte Black graphics that will have the competition staring and the fish running scared.



DF250ATSSW

STANDARD FEATURES



ADDITIONAL FEATURES FOR DRIVE BY WIRE MODEL

Durability & Reliability

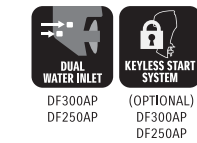

Ease & Comfort

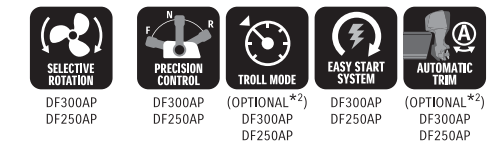

Ecology & Economy



*1 Available with SMD or SMG *2 Available with SMD, SMG, or Troll Mode Switch Panel

SPECIFICATIONS & FEATURES

SPECIFICATIONS	NEW	NEW								
	350AMD	300BMD	350A	300B	300AP	250AP	250	225		
STARTING SYSTEM	Electric		Electric		Electric		Electric			
RECOMMENDED TRANSOM HEIGHT in	L: 20 X: 25 XX: 30		X: 25 XX: 30		L: 20 ² X: 25 XX: 30		X: 25 XX: 30	X: 25 XX: 30		
WEIGHT lbs	L: 761 X: 776 XX: 794		X: 728 XX: 745		L: 626 X: 639 XX: 659		X: 606 XX: 626	X: 606 XX: 626		
VALVE TRAIN	DOHC 4 Valves		DOHC 24-Valve		DOHC 24-Valve		DOHC 24-Valve			
VALVE TRAIN DRIVE	Chain		Chain		Chain		Chain			
DISPLACEMENT in ³	267.9		267.9		245.6		220.5			
MAXIMUM OUTPUT HP	350	300	350	300	300	250	250	225		
BORE & STROKE in	3.86 x 3.81		3.86 x 3.81		3.86 x 3.50		3.74 x 3.35			
OPERATION RANGE rpm	5,700-6,300	5,700-6,300	5,700-6,300	5,300-6,300	5,700-6,300	5,500-6,100	5,500-6,100	5,000-6,000		
FUEL DELIVERY SYSTEM	Electronic Fuel Injection		Electronic Fuel Injection		Electronic Fuel Injection		Electronic Fuel Injection			
OIL PAN CAPACITY QTS	8.4		8.4		8.4		8.4			
ALTERNATOR	12V 54A		12V 54A		12V 54A		12V 54A			
TRIM TYPE	Power Trim and Tilt		Power Trim and Tilt		Power Trim and Tilt		Power Trim and Tilt			
GEAR RATIO	2.29:1		2.29:1		2.08:1		2.29:1			
CONTROL SYSTEM	DBW		Digital		Digital		Mechanical			
RECOMMENDED FUEL	89 Octane	87 Octane	89 Octane	87 Octane	89 Octane		87 Octane			
PROPELLER SELECTION (PITCH)	12"-31.5"		12"-31.5"		15"-27.5" (R/R) 17"-26" (C/R)		15"-27.5" (R/R) 17"-26" (C/R)			

All propellers are the 3-blade type. Please inquire at your local dealer for details of the propeller.
*1: Dry Weight: Including battery cable, not including propeller and engine oil. *2: DF300AP only

250ATSSW	250SS	200RSS	150SS	115BSS	200AP	175AP	150AP	200A	175A	150A
Electric					Electric			Electric		
L: 20 X: 25					L: 20 X: 25			L: 20 X: 25		
L: 626 X: 639	L: 578 X: 606	L: 518 X: 529	L: 518 X: 529	L: 410 X: 419	L: 520 X: 531			L: 518 X: 529		
DOHC 4 valves per cylinder					DOHC 16-Valve			DOHC 16-Valve		
Chain					Chain			Chain		
245.6		175.0	175.0	124.7	1,129			1,129		
250		200	150	115	200	175	150	200	175	150
3.81 x 3.46	3.81 x 3.46	3.81 x 3.81		3.40 x 3.50	3.8 x 3.8			3.8 x 3.8		
5,500-6,100	5,300-6,300	5,500-6,100	5,000-6,000	5,600-6,000	5,500-6,100		5,000-6,000	5,500-6,100	5,000-6,000	
Multi-Point Sequential Fuel Injection					Electronic Fuel Injection			Electronic Fuel Injection		
8.0					8.4			8.4		
12V 54A	12V 44A			12V 40A	12V 44A			12V 44A		
Power Trim and Tilt					Power Trim and Tilt			Power Trim and Tilt		
2.08:1	2.0:1		2.5:1	2.59:1	2.50:1			2.50:1		
Remote					Digital			Mechanical		
87 Octane					87 Octane			87 Octane		
17"-30"				9"-26"	15"-27.5" (R/R) 17"-26" (C/R)			15"-27.5" (R/R) 17"-26" (C/R)		

All propellers are the 3-blade type. Please inquire at your local dealer for details of the propeller.
*1: Dry Weight: Including battery cable, not including propeller and engine oil. *2: DF300AP only

FEATURES	NEW	NEW								
	350AMD	300BMD	350A	325A	300B	300AP	250AP	250	225	
BODY COLOR	Black	●	●	●	●	●	●	●	●	●
	White	●	●	●	●	●	●	●	●	●
INTEGRATED STEERING	●	●	●	●	●	●	●	●	●	●
SUZUKI DUAL LOUVER SYSTEM	●	●	●	●	●	●	●	●	●	●
SELF ADJUSTING TIMING CHAIN	●	●	●	●	●	●	●	●	●	●
SUZUKI ANTI-CORROSION SYSTEM	●	●	●	●	●	●	●	●	●	●
OVER-REV. LIMITER	●	●	●	●	●	●	●	●	●	●
TILT LIMIT SYSTEM	●	●	●	●	●	●	●	●	●	●
WATER DETECTING SYSTEM	●	●	●	●	●	●	●	●	●	●
FRESH WATER FLUSHING SYSTEM	●	●	●	●	●	●	●	●	●	●
DUAL WATER INLET	●	●	●	●	●	●	●	●	●	●
SUB WATER INLET	○	○	○	○	○	○	○	○	○	○
NEW KEYLESS START SYSTEM	○	○	○	○	○	○	○	○	○	○
SDSM ^{*1}	○	○	○	○	○	○	○	○	○	○
OFFSET DRIVESHAFT	●	●	●	●	●	●	●	●	●	●
2-STAGE GEAR REDUCTION	●	●	●	●	●	●	●	●	●	●
HIGH ENERGY ROTATION	●	●	●	●	●	●	●	●	●	●
SUZUKI DUAL PROP SYSTEM	●	●	●	●	●	●	●	●	●	●
VARIABLE VALVE TIMING	●	●	●	●	●	●	●	●	●	●
MULTI-STAGE INDUCTION	●	●	●	●	●	●	●	●	●	●
SUZUKI SELECTIVE ROTATION	●	●	●	●	●	●	●	●	●	●
SUZUKI PRECISION CONTROL	●	●	●	●	●	●	●	●	●	●
NOISE REDUCTION	●	●	●	●	●	●	●	●	●	●
OVERHEAD TANK	○	○	○	○	○	○	○	○	○	○
AUTOMATIC TRIM ^{*2}	○	○	○	○	○	○	○	○	○	○
GAS ASSIST SYSTEM	○	○	○	○	○	○	○	○	○	○
THREE-WAY STORAGE	○	○	○	○	○	○	○	○	○	○
SUZUKI TROLL MODE SYSTEM ^{*2}	○	○	○	○	○	○	○	○	○	○
SUZUKI EASY START SYSTEM	●	●	●	●	●	●	●	●	●	●
LEAN BURN CONTROL SYSTEM	●	●	●	●	●	●	●	●	●	●
DUAL INJECTOR	●	●	●	●	●	●	●	●	●	●
O2 SENSOR FEEDBACK CONTROL SYSTEM	○	○	○	○	○	○	○	○	○	○
SHALLOW WATER DRIVE	○	○	○	○	○	○	○	○	○	○

*1: available by using with SMD/SMG4 *2: available by using with SMD/SMG4/Troll Mode Switch Panel *3: available by using with SMG4/SMD, and New S.P.C.

250ATSSW	250SS	200RSS	150SS	115BSS	200AP	175AP	150AP	200A	175A	150A
●	●				●	●	●	●	●	●
●					●	●	●	●	●	●
●	●	●	●	●	●	●	●	●	●	●
●	●	●	●	●	●	●	●	●	●	●
●	●	●	●	●	●	●	●	●	●	●
●	●	●	●	●	●	●	●	●	●	●
●	●	●	●	●	●	●	●	●	●	●
●	●	●	●	●	●	●	●	●	●	●
○	○	○	○	○	○	○	○	○	○	○
○	○	○	○	○	○	○	○	○	○	○
●	●	●	●	●	●	●	●	●	●	●
●	●	●	●	●	●	●	●	●	●	●
○	○	○	○	○	○	○	○	○	○	○
○	○	○	○	○	○	○	○	○	○	○
●	●	●	●	●	●	●	●	●	●	●
●	●	●	●	●	●	●	●	●	●	●
○	○	○	○	○	○	○	○	○	○	○
○	○	○	○	○	○	○	○	○	○	○
●	●	●	●	●	●	●	●	●	●	●
●	●	●	●	●	●	●	●	●	●	●

●=Standard Equip. ○=Optional Equip.

NEW SUZUKI DIAGNOSTIC SYSTEM MOBILE PLUS (SDSM+)

DF9.9B AND UP

*Available with SMD or SMG4

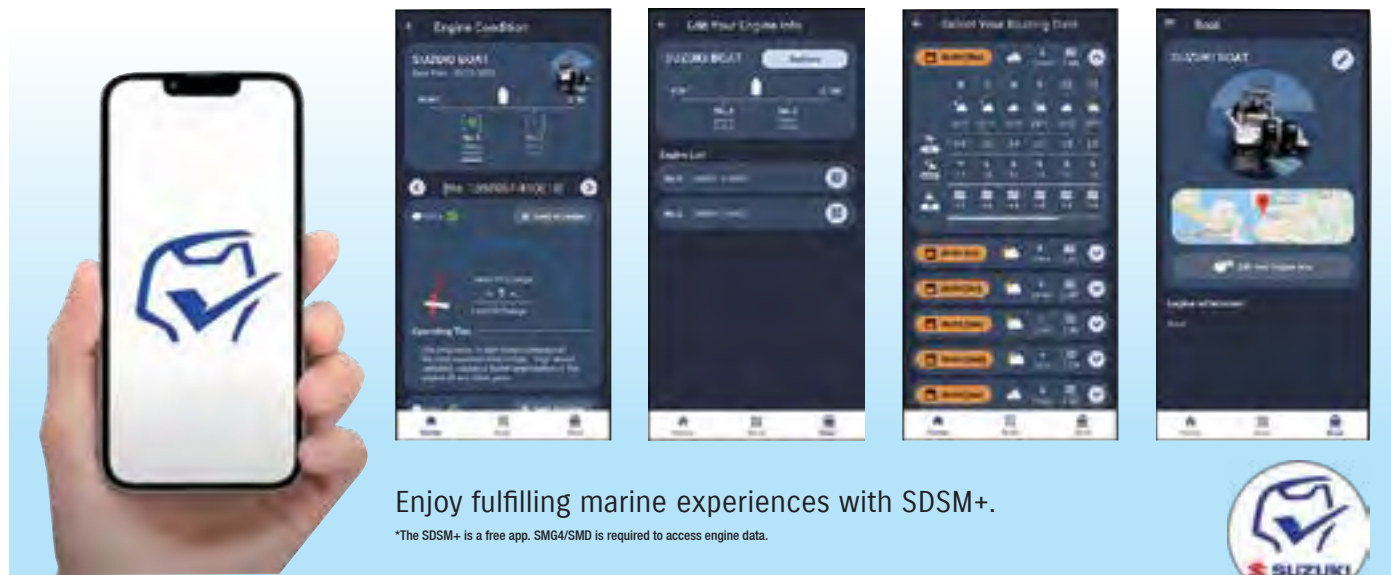

Enjoy fulfilling marine experiences with SDSM+.

*The SDSM+ is a free app. SMG4/SMD is required to access engine data.

3 FEATURES OF THE SDSM+

1. PLAN A BOAT TRIP WITH THE FORECAST

- + You can make a boating plan and refer to the weather, wind, and wave condition at a designated point.
- + The app also shows the weekly weather forecast, which is constantly updated.

2. INSPECT BOAT AND OUTBOARD MOTOR IN ADVANCE

- + Outboard motor can be checked based on the engine data.
- + You can share engine data with your dealer, which can shorten the service time.

3. ACQUIRE ENGINE DATA

- +You can check the engine condition and your driving tendencies.
- +You can provide engine data to your dealer, to check engine maintenance reminders.



Apple and the Apple Logo are trademarks of Apple Inc., registered in the U.S. and other countries. App Store is a service mark of Apple Inc., registered in the U.S. and other countries.



Google Play and the Google Play Logo are trademarks of Google LLC.

HOW TO GET THE ENGINE DATA

1. The outboard will convert engine data into a QR code* displayed on the SMG4 or SMD.
2. Open the app and scan the QR code. The app will receive the engine data and automatically attach it to an e-mail.
3. You can then send the e-mail to your nearby dealer to shorten the maintenance time.



Find out more at our Global Website



SUZUKI PRECISION CONTROL FOR DRIVE-BY-WIRE SYSTEM

DF350AMD/300BMD DF350A/325A/300B DF300AP/250AP DF200AP/175AP/150AP DF140BG/115BG

Suzuki's best technology lies in the Suzuki Precision Control (S.P.C.) for Drive-By-Wire System. The S.P.C. enables instant, precise throttle response for greater control and accuracy.

FEATURES

- Control up to 6 outboard engines.
- 1-action start for multi-engine boats: Engines start in order from port to starboard.
- Automatic Trim is available with SMD or SMG4.
- 1 Lever Operation : This switch allows multiple engine operation with just 1 lever. (Dual top mount only)
- Integrated Emergency Switch (Flush Mount only)

REMOTE CONTROL BOX

Integrated "Select" and "Throttle Only" switch (All)



SINGLE TOP MOUNT

DUAL TOP MOUNT

FLUSH MOUNT

CONTROL PANEL



SWITCH PANEL FOR REGULAR KEY



KEYLESS START SYSTEM*

All S.P.C. models and DF200A/175A/150A, DF140B/115B, DF90A/70A

DESIGN

How to use

1. Stand nearby the console with the key fob.
2. Push START/STOP button to start engine.
3. To turn off the engine, push the button again.

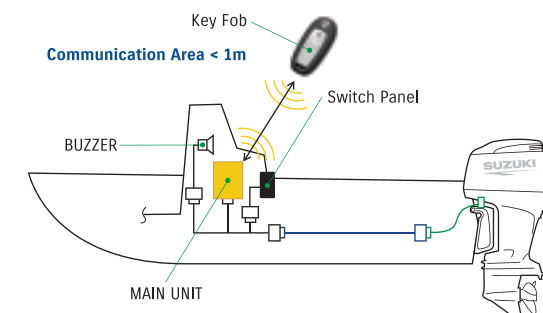

Find out more by watching our videos

*Please check applicability with your local Suzuki dealer.

FEATURES

- 3 types of panels are available: Horizontal, Vertical and Individual.
- 1-push Start/Stop, and controls up to 6 engines. No ignition key necessary.



MAINTENANCE KITS

Suzuki provides Maintenance Kits for quick and reliable service. Each Kit comes with all the specific maintenance parts necessary for your model.



Please ask your local Suzuki dealer for the contents of each kit and applicable models.



PARTS & ACCESSORIES

SUZUKI MULTI-FUNCTION GAUGE (SMG4) DF9.9B AND UP

Suzuki Multi-Function Gauge provides all performance information in one gauge. Individual elements can also be emphasized to further enhance user friendliness.

SMG4



DAY MODE



NIGHT MODE

FEATURES



Multilingual Menu



Automatic Trim Function



Automatically adjusts trim angle.

ANALOG TACHO & SPEED MODE

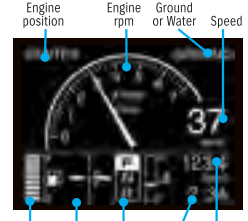

Troll Mode



SPECIFICATIONS

- 3.5 Color Display
- Size: 4.13 in. (W) x 4.13 in. (H) x 0.63 in. (D)
- NMEA2000 output
- Shows both digital and analogue readouts, as well as day/night mode
- Displays the QR code* for SDSM / SDSM+
- Troll Mode Function: Allows user to control troll mode (only for 2019MY and newer models adapted to troll mode)

English, French, Italian, German, Spanish, Swedish, Norwegian, Finnish, Dutch, Portuguese, Danish, Russian, Japanese

* DENSO WAVE owns the rights of the name and the logo of QR code.

SUZUKI MULTI-FUNCTION DISPLAY (SMD) DF9.9B AND UP

KEY FEATURES

- Intuitive, easy, smooth operation with an entire multi touch screen interface. Total control at your fingertips
- Bonded all-glass LCD, sunlight viewable screen with impressive brightness, and a luxurious look
- Ease of operation with all Suzuki engine information integrated on one display
- Technologies such as TruEcho Chirp™, Accu-Fish™, RezBoost™ combined in one display to provide you the most exciting fishing experience



WATERGRIP PROPELLER

WATERGRIP is a stainless-steel propeller series offering accurate response to your operation. With this propeller series efficiently converts engine power into propulsion, and meets our customers' demand for bigger, faster, more powerful outboards.

The WATERGRIP propeller series employs a new interchangeable and square shaped propeller bushing that minimizes power loss in delivery.

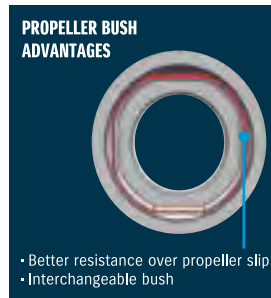

• Better resistance over propeller slip
• Interchangeable bush



WATERGRIP



WATERGRIP DUAL



WATERGRIP SPORT

MULTI-FUNCTION TILLER HANDLE DF115B/100C DF100B/DF70A-90A DF60A/50AV/60AV DF40A/50A



Main features



Tachometer* with warning indicators

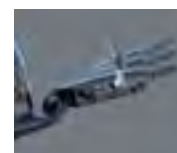

Three-position angle adjustable bracket



Troll mode switch* - Activates SUZUKI Troll Mode System and controls RPM from idling engine speed up to 1200rpm at every 50rpm.



Power trim & tilt switch* and throttle grip friction adjuster

ECSTAR

GENUINE OIL & CHEMICAL

What is ECSTAR

ECSTAR is a global brand name of SUZUKI Genuine Oil & Chemicals.

The ULTIMATE Formulation

Suzuki Approved Genuine engine oils have all been rigorously tested and certified by Suzuki engineers. You can be confident that they'll help keep your Suzuki outboard in perfect condition, giving you maximum performance and reliability over its lifetime.

ECSTAR Line up for OUTBOARD MOTOR



Availability may differ in some regions. Please contact your Suzuki local dealer.

Integrated Control System

"SYNCRO-EYE" is a comprehensive system Suzuki has developed which "connects" various devices that work together in synchronization. This innovative system will help improve the control technology of the vessel by "sensing" various situations and will also be compatible with future technologies.

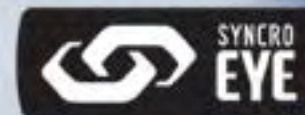

Continuously evolving over the decades, Suzuki has a rich, proud history knowing no bounds.

D55

The first Suzuki Outboard, D55, was marketed.

SPECIFICATIONS

2-stroke
Cylinder : 1
Displacement : 5.98 cu.in.
Maximum output : 5.5 HP



1965

DT200 Exanté

DT200 Exanté won the first "Most Innovative Products" award from the show's sponsor, the National Marine Manufacturers association (NMMA).

SPECIFICATIONS

2-stroke
Cylinder : V6
Displacement : 164.38 cu.in.
Maximum output : 200 HP



1987

DF60/70

DF60 and DF70, the first Suzuki 4-stroke outboards with Electric Fuel Injection System, were marketed. DF60 and DF70 won the "NMMA Innovation Award"

SPECIFICATIONS

4-stroke
Cylinder: 4
Displacement : 57.4 cu.in.
Maximum output : 60/70 HP



1997

DF300

DF300 is the industry's first 220.7kW(300PS) V6 4-stroke outboard, and the first outboard to utilize an electronic remote control. DF300 is the winner of the "NMMA 2006 Innovation Award"

SPECIFICATIONS

4-stroke
Cylinder : V6
Displacement : 245.6 cu.in.
Maximum output : 300 HP



2006

DF350A

Suzuki introduces DF350A 350 HP V6 4-stroke outboard. New Flagship Model Features Innovative Contra-Rotating Propellers, More Exclusive Features. DF350A is the winner, the "NMMA 2017 Innovation Award".

SPECIFICATIONS

4-stroke
Cylinder : V6
Displacement : 267.89 cu.in.
Maximum output : 350 HP



2017

100th Anniversary of Suzuki's Long History

With the rich history of 100 years, and the experience and knowledge of automobile, motorcycle, and outboard motor development, Suzuki has come to provide technology and service unprecedented in the marine business.

Combined with the "Yamaika" spirit, Suzuki has grown to create innovation and satisfaction to customers around the world.

2020

1977

DT5

The DT5 was released as a compact 3.7kW(5PS) outboard motor. The Mounted 2-cylinder engine, on, while 1-cylinder had been used for conventional 5PS outboard motor at that time, delivered powerful propulsion.

SPECIFICATIONS

2-stroke
Cylinder : 2
Displacement : 6.89 cu.in.
Maximum output : 5 HP

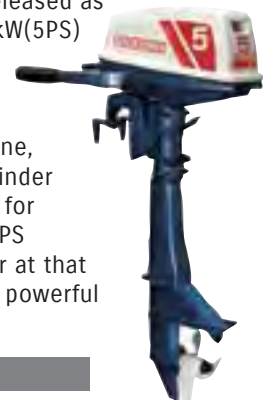

1994

DF9.9

Suzuki introduced DF9.9 and DF15, their first 4-stroke outboards.

SPECIFICATIONS

4-stroke
Cylinder : 2
Displacement : 18.42 cu.in.
Maximum output : 9.9 HP



2003

DF250

DF250 is the industry's first 184kW(250PS) 4-stroke outboard. DF200/225/250, the first Suzuki 4-stroke V6 outboards were revealed. DF250 won the "NMMA Innovation Award" at the 2003 International Miami Boat Show.

SPECIFICATIONS

4-stroke
Cylinder : V6
Displacement : 220.54 cu.in.
Maximum output : 250 HP



2014

DF200AP

DF200A/DF200AP are 4-stroke outboard motors based on in-line 4-cylinder engine of the DF175. In addition, DF200AP has adopted the Suzuki Selective Rotation, the world's first technology to integrate both regular and counter rotations of a propeller. The control system utilizes electronic throttle and shift systems.

SPECIFICATIONS

4-stroke
Cylinder : In-line 4
Displacement : 175 cu.in.
Maximum output : 200 HP



DF90A

DF90AWQH was developed to meet the demand of commercial fishing. It is the first model in Suzuki's commercial series.

SPECIFICATIONS

4-stroke
Cylinder : In-line 4
Displacement : 91.8 cu.in.
Maximum output : 90 HP



DF140BG

DF140BG is the world's first drive by wire model in 4-stroke (140HP). It inherits the reliability & fuel efficiency of DF140A, and cutting-edge technologies realizing higher durability & performance.

SPECIFICATIONS

4-stroke
Cylinder : In-line 4
Displacement : 124.7 cu.in.
Maximum output : 140 HP





Please read your Owner's Manual carefully. Remember, boating and alcohol or other drugs don't mix. Always wear a personal flotation device when boating. Please operate your outboard safely and responsibly.

Suzuki encourages you to operate your boat safely and with respect for the marine environment.

Specifications, appearances, equipment, colors, materials and other items of "SUZUKI" products shown in this catalogue are subject to change by manufacturers at any time without notice and they may vary depending on local conditions or requirements. Each model might be discontinued without notice. Please enquire at your local dealer for details of any such changes. Actual body color might differ from the colors in this brochure.



Suzuki Marine USA, LLC

13521 Prestige Pl.
Tampa, FL 33685-2529
www.suzukimarine.com

2023 FULL LINE CATALOG
99953-22501
Printed in the U.S.A.

©2023 Suzuki Marine USA, LLC. All rights reserved.



suzukimarine.com