

SUZUKI MARINE  
**OUTBOARD  
MOTORS**  
FULL LINE CATALOG



THE  
**ULTIMATE™**  
OUTBOARD MOTOR

# SUZUKI CLEAN OCEAN PROJECT

As the world's ULTIMATE OUTBOARD MOTOR brand, Suzuki always remains focused on providing the ultimate marine experience, which requires a healthy and clean marine environment.

Since 2010, we have been voluntarily conducting the "Clean-Up the World Campaign" every year to contribute to a better marine environment and more than 10,000 people have participated. In Japan, the campaign has been officially recognized by the Ministry of the Environment in the "Plastic Smart Campaign".

To continue to make our utmost effort for environmental protection, it is now time for us to review how we have been contributing to the environment and society and newly determine our direction. As well as continuing our worldwide clean-up campaign, we will also commit to take responsible actions against plastic waste problems. This is how we came to make the new Slogan and Logo, "SUZUKI CLEAN OCEAN PROJECT", to show the world our commitment.

## Our Commitment

1. Clean-Up the World Campaign
2. Reduce Plastic Packaging
3. Collect Marine Micro-Plastic Waste



We believe the actions Team Suzuki takes around the world will be one positive step forward to a cleaner marine environment.

## CONTENTS

- 4-5 **SUZUKI CLEAN OCEAN PROJECT**
- 6-7 **SUZUKI ULTIMATE TECHNOLOGY**
- 12-13 **SHINOBI: STEALTH LINE** **NEW**
- 14-15 **STEALTH LINE ENGINES** **NEW**
  - DF250A STEALTH
  - DF250 STEALTH
  - DF200/150 STEALTH
  - DF115B STEALTH
- 16-17 **GEKI: 350-300HP FLAGSHIP**
  - DF350AMD/300BMD
  - DF350A/300B
- 18-19 **V6 300-225HP**
  - DF300AP/250AP
  - DF250/225
- 20-21 **IN-LINE 4 200-150HP**
  - DF200AP/175AP/150AP
  - DF200A/175A/150A
- 22-23 **IN-LINE 4 140-75HP**
  - DF140BG/115BG
  - DF140B/115B
  - DF90A/75A
- 24-25 **IN-LINE 3 60-25HP**
  - DF60AV/50AV
  - DF60A/50A/40A
  - DF30A/25A
- 26-27 **PORTABLE 20-2.5HP**
  - DF20A/15A/9.9B
  - DF6A/4A
  - DF2.5
- 28-29 **SUZUKI PERFORMANCE & DURABILITY**
- 30-32 **PARTS & ACCESSORIES**
- 33 **ECSTAR/SYNCRO EYE**
- 34-35 **HISTORY**
- 36-39 **SPECIFICATIONS & FEATURES**



# SUZUKI CLEAN OCEAN PROJECT

In order to clean the ocean, Suzuki Marine will promote the “SUZUKI CLEAN OCEAN PROJECT” together with partners and boaters all around the world. To reduce marine plastic pollution, Suzuki has set up the Suzuki CLEAN OCEAN PROJECT and has been promoting these activities under it’s three commitments.

## CLEAN-UP THE WORLD CAMPAIGN

More than **15,000** people from **75** groups participated in this activity.\*



ACE MARINE SEYCHELLES



SUZUKI PHILIPPINES INC.



SUZUKI MOTOR (CHINA) INVESTMENT CO., LTD.



SUZUKI MARINE USA

\*As of July, 2023

## REDUCE PLASTIC PACKAGING

In order to avoid to produce additional plastics, we have been replacing the plastic packaging of outboards and marine genuine parts to eco-conscious materials.

Packaging for Suzuki Marine genuine parts



Plastic Packaging



Paper Packaging

■ Oct.2020 - Jun.2023 : Reduced **17.7t**.  
Replacing the plastic packaging to Paper.



■ Sep.2021 - Jun.2023 : Reduced **24.7t**.

- ① Outer Carton (Polyethylene → Paper)
- ② Body Cover (Polyethylene → Biodegradable Material)
- ③ Engine Cover ( Nylon → Rayon)
- ④ Cushioning Material (Polystyrene Foam → Biodegradable Material)

## COLLECT MARINE MICRO-PLASTIC WASTE

As a solution to the plastics flowing into the oceans, which are not collected properly on land, Suzuki developed the world's first Micro-Plastic Collecting (MPC) device installed on outboard motors.

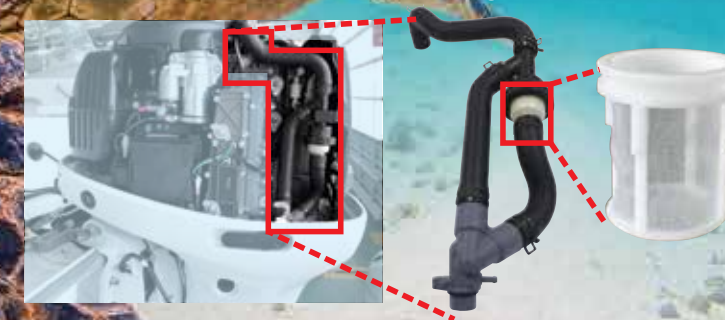

BEFORE 22 MODEL YEAR WITH MICRO-PLASTIC COLLECTING DEVICE



### FEATURES

- Will not affect the performance of the engine even if the filter gets clogged since this device utilizes the used cooling water.
- Produces no negative effects on the environment.



Garbage-contaminated seawater

Micro-Plastic collector makes the sea beautiful

Collected materials



**DF140BG**  
**DF115BG**

DRIVE BY WIRE with MPC

**DF140B**  
**DF115B**



**STANDARD**  
FROM 23 MODEL YEAR  
DF140BG / 115BG  
DF140B / 115B

LEADING THE INDUSTRY WITH AWARD WINNING TECHNOLOGIES AND DESIGNS, SUZUKI OUTBOARDS PROVIDE FEATURES AND BENEFITS THAT MAKE BOATING EVEN MORE ENJOYABLE

Durability & Reliability	Performance	Ease & Comfort	Ecology & Economy
<ul style="list-style-type: none"> <li>Durable</li> <li>Notifies user before engine trouble</li> <li>Easy to service, repair</li> </ul> <div style="display: flex; flex-wrap: wrap; gap: 5px;"> <div style="width: 50%; text-align: center;"></div> <div style="width: 50%; text-align: center;"></div> <div style="width: 50%; text-align: center;"></div> <div style="width: 50%; text-align: center;"></div> <div style="width: 50%; text-align: center;"></div> <div style="width: 50%; text-align: center;"></div> <div style="width: 50%; text-align: center;"></div> <div style="width: 50%; text-align: center;"></div> <div style="width: 50%; text-align: center;"></div> </div>	<ul style="list-style-type: none"> <li>Smooth and quick acceleration at all operating ranges</li> <li>Powerful torque</li> </ul> <div style="display: flex; flex-wrap: wrap; gap: 5px;"> <div style="width: 50%; text-align: center;"></div> <div style="width: 50%; text-align: center;"></div> <div style="width: 50%; text-align: center;"></div> <div style="width: 50%; text-align: center;"></div> <div style="width: 50%; text-align: center;"></div> <div style="width: 50%; text-align: center;"></div> <div style="width: 50%; text-align: center;"></div> </div>	<ul style="list-style-type: none"> <li>Less vibration</li> <li>Quiet operation</li> <li>Light &amp; Compact</li> <li>Easy to use</li> <li>Smooth and Decisive shifting</li> </ul> <div style="display: flex; flex-wrap: wrap; gap: 5px;"> <div style="width: 50%; text-align: center;"></div> <div style="width: 50%; text-align: center;"></div> <div style="width: 50%; text-align: center;"></div> <div style="width: 50%; text-align: center;"></div> <div style="width: 50%; text-align: center;"></div> <div style="width: 50%; text-align: center;"></div> <div style="width: 50%; text-align: center;"></div> <div style="width: 50%; text-align: center;"></div> <div style="width: 50%; text-align: center;"></div> <div style="width: 50%; text-align: center;"></div> </div>	<ul style="list-style-type: none"> <li>Good fuel efficiency / low exhaust emissions</li> <li>Low maintenance cost</li> <li>Environmental protection activities</li> </ul> <div style="display: flex; flex-wrap: wrap; gap: 5px;"> <div style="width: 50%; text-align: center;"></div> <div style="width: 50%; text-align: center;"></div> <div style="width: 50%; text-align: center;"></div> <div style="width: 50%; text-align: center;"></div> </div>

## Durability & Reliability



### SUZUKI DUAL LOUVER SYSTEM

▶DF350AMD/300BMD ▶DF350A/300B

Dog-leg shaped dual louvers remove water from the air directed into the cowlings.

#### ADVANTAGE

- Prevents water intrusion.
- Allows a direct intake system, contributing to higher engine output.



### SELF-ADJUSTING TIMING CHAIN

▶DF40A AND UP

The timing chain running in an oil-bath is adjusted automatically by hydraulic tensioner.

#### ADVANTAGE

- More durable than the belt type.
- Maintenance-free.



### DUAL WATER INLET

▶DF350AMD/300BMD ▶DF350A/300B  
▶DF300AP/250AP ▶DF250A/250STEALTH

The engine's cooling system relies on water supplied through two water inlets located on the lower unit.

#### ADVANTAGE

- Increases the water flow, providing better cooling performance.



### WATER DETECTING SYSTEM

▶DF75A AND UP

A water detecting fuel filter system. When water is detected, the system will alert the driver with visual and audio warnings.

#### ADVANTAGE

- Helps prevent lower power output and corrosion by alerting driver of water intrusion.



### TILT LIMIT SYSTEM

▶DF50AV AND UP  
(not including DF50A/40A)

Tilt Limit System prevents the outboard from tilting beyond a selected angle.

#### ADVANTAGE

- Prevents damage to the boat or outboard due to excessive outboard tilting.

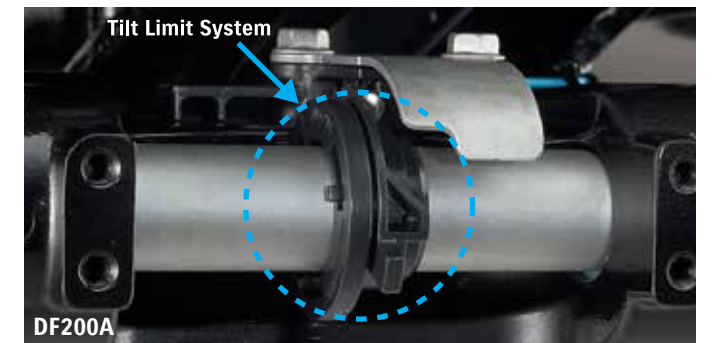

### SUB WATER INLET

OPTIONAL: ▶DF140BG/115BG ▶DF140B/115B  
STANDARD: ▶DF60A/50A/40A

Two water inlets in different directions ensure that the engine does not overheat due to clogging by sea grass or algae.

### NMMA Innovation Awards

The Innovation Awards (recognizing technological innovation) awarded each year by the NMMA (National Marine Manufacturers Association) are considered among the highest honor in marine technology. Of the new marine industry products in that year, they are awarded to "a product that shows technical leadership, is practical and cost-effective, and is truly beneficial to the consumer."

Starting with the DT200 Exanté in 1987 and extending to the DF350A in 2017, Suzuki outboard motors have received this Innovation Award a total of nine times. Eight of these awards are for 4-stroke outboard motors.



#### Awarded Prizes

1987: DT200 Exanté	2011: DF50A & DF40A
1997: DF70 & DF60	2012: DF300AP
1998: DF50 & DF40	2014: DF30A & DF25A
2003: DF250	2017: DF350A
2006: DF300	



## KEYLESS START SYSTEM

OPTIONAL: ▶DF350AMD/300BMD ▶DF350A/300B  
▶DF300AP/250AP ▶DF250A/250STEALTH  
▶DF200AP/175AP/150AP ▶DF200A/175A/150A  
▶DF140BG/115BG ▶DF140B/115B  
▶DF90A/75A

This system allows you to start multiple engines by placing a key-fob nearby.

- One push Start & Stop for up to 6 outboard motors.
- Waterproof Float Key Fob.
- Security support with immobilizer.

### ADVANTAGE

- Provides high security.
- Ignition key is not required.



## SUZUKI ANTI-CORROSION FINISH

▶ALL MODELS

Special protection is applied to the aluminum surface using high strength bonding to protect the aluminum made exterior parts.

### ADVANTAGE

- Protection against corrosion helps increase the overall outboard durability.

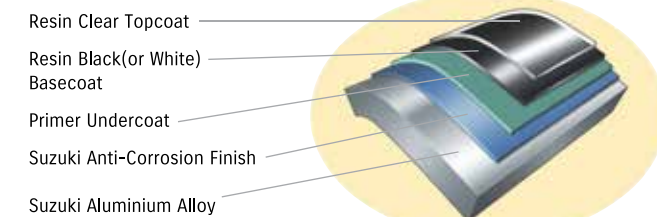

## NEW SDSM+ (SUZUKI DIAGNOSTIC SYSTEM MOBILE+)

▶DF9.9B AND UP\*

Use the app to plan for boating by checking the weather forecast, the engine condition and operation tips. All functions are available for free.\* Please check our website and page 32 for more details.

\*SMD/SMG4 and a smartphone running Android/iOS are required.

### ADVANTAGE

- Possible to make a plan for boat trip by checking the weather forecast in advance.
- Check up on the engines before the departure based on the engine data.
- Acquire the engine data by scanning the QR code\*.
- Provide the engine data to dealer and ask for maintenance easily.

\*DENSO WAVE owns the rights of the name and the logo of QR code.

# Performance



## OFFSET DRIVESHAFT

▶DF75A AND UP

The engine powerhead is positioned closer to the front, moving the outboard's center of gravity forward.

### ADVANTAGE

- Less vibration
- More compact
- Stable steering performance

1st Stage Reduction : 30:36=1.20  
2nd Stage Reduction : 12:25=2.08

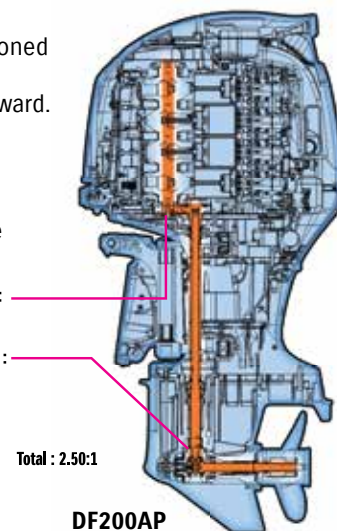

## 2-STAGE GEAR REDUCTION

▶DF75A AND UP

This design makes a lower gear ratio possible, allowing it to turn a larger diameter higher pitch propeller.

### ADVANTAGE

- Increased power to turn large diameter propellers, offering quick acceleration.
- High propulsive efficiency with large diameter propeller.
- Powerful navigation, maintaining propeller rotation even with a larger load.

### GEAR RATIO IN EACH CLASS

MODEL	DF140BG/115BG DF140B/115B 90A/75A	DF200A(AP)/ 175A(AP)/150A(AP)	DF250/ 225	DF300AP/250AP/ DF250A STEALTH/ DF250 STEALTH	DF350AMD/ 300BMD DF350A/300B
GEAR RATIO	2:59:1	2:50:1	2:29:1	2:08:1	2:29:1



## HIGH ENERGY ROTATION

▶DF60AV/50AV

Larger lower units (2.42 gear ratio) make it possible to equip larger 36cm (14-inch) propeller than other models in this class. It offers better acceleration and more power.

### ADVANTAGE

- Powerful torque to carry heavy loads.
- Quick acceleration with larger propellers.
- Quick and smooth planing.

### DF60AV vs. DF60A size comparison

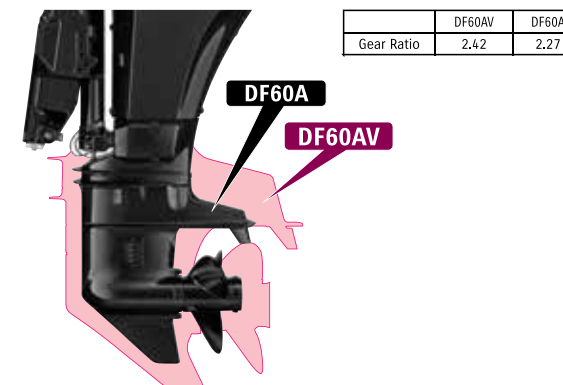

## VVT (Variable Valve Timing)

▶DF350AMD/300BMD ▶DF350A/300B  
▶DF300AP/250AP ▶DF250A/250STEALTH  
▶DF200AP/175AP/150AP ▶DF200A/175A

The Variable Valve Timing controls the opening and closing timing of the intake valves depending on the engine RPM.

### ADVANTAGE

- Offers smooth, powerful torque.
- Provide smooth acceleration across all speed ranges.

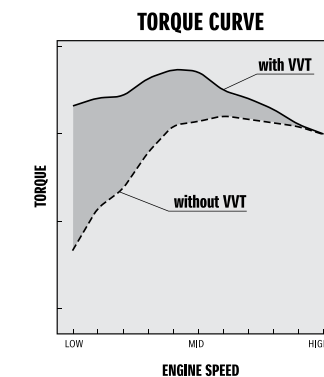

## MULTI-STAGE INDUCTION

▶DF250/225 ▶DF200AP/175AP/150AP  
▶DF200A/175A/150A ▶DF250A/250STEALTH

Intake manifold pipes are switched between short and long during low speed and high speed operation to ensure the right volume of air enters the engine.

### ADVANTAGE

- Increases output during high speed operation with greater volume of air input.
- Increases combustion efficiency and maximizes torque during low speed operation.

### AIR FLOW IN MULTI-STAGE INDUCTION MODULE

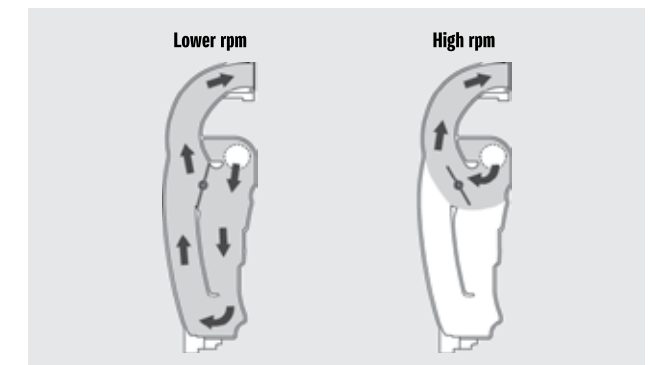

## DIRECT AIR INTAKE

▶DF350AMD/300BMD ▶DF350A/300B

A direct airflow path from the intake port to the cylinder suppresses temperature rise of the air and improves combustion efficiency.

### ADVANTAGE

- Delivers higher power output from a small displacement.



## SUZUKI DUAL PROP SYSTEM

▶DF350AMD/300BMD ▶DF350A/300B

The Suzuki Dual Prop System spins two propellers rotating in opposite directions on a single lower unit. With the 6 blades, it can get a better grip on the water.

### ADVANTAGE

- Achieve superior stability when driving straight.
- Powerful reverse thrust and braking force.
- Good water gripping performance and quick startup acceleration.

## Ease & Comfort



### SUZUKI SELECTIVE ROTATION

▶DF300AP/250AP ▶DF200AP/175AP/150AP

Function for selecting regular or counter rotation on one outboard with an optional connector and a counter rotation propeller.

#### ADVANTAGE

- Either regular or counter rotation can be used on the same outboard.



### THREE-WAY STORAGE

▶DF6A/4A

The design allows the outboard to be removed from the boat and placed on any of its 3 sides for storage.

#### ADVANTAGE

- No need to worry about the loading space or method.



### SUZUKI PRECISION CONTROL (Electronic Throttle and Shift Systems)

▶DF350AMD/300BMD ▶DF350A/300B ▶DF300AP/250AP  
▶DF250ASTEALTH ▶DF200AP/175AP/150AP ▶DF140BG/115BG

Operation from the remote control is delivered to the outboard via an electric signal and it enables the 1 lever operation for up to 6 outboard motors (for dual mount only).

#### ADVANTAGE

- Reduced friction and resistance compared to the mechanical controls.
- Easy control for multiple outboard motors.
- Improved fuel economy with the combination of Lean Burn Control System.



### OVERHEAD TANK

▶DF6A/4A

The integral overhead fuel tank and one-way valve delivers fuel supply by using gravity.

#### ADVANTAGE

- Contributes to easy start.



### AUTOMATIC TRIM\*

▶DF350AMD/300BMD ▶DF350A/300B ▶DF300AP/250AP  
▶DF200AP/175AP/150AP ▶DF250  
▶DF200A/175A/150A ▶DF140BG/115BG ▶DF140B/115B

The Auto Trim feature adjusts the trim angle automatically depending on the engine RPM.



### NOISE REDUCTION

▶DF350AMD/300BMD ▶DF350A/300B  
▶DF200AP/175AP/150AP ▶DF200A/175A/150A  
▶DF140BG/115BG ▶DF140B/115B

Intake noise is suppressed with silencer and resonator.

#### ADVANTAGE

- Less noise, makes boating more enjoyable.

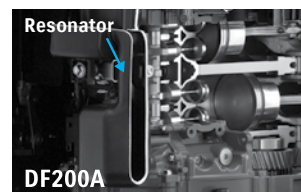

### SUZUKI TROLL MODE SYSTEM\*

▶DF40A AND UP  
Optional for Remote Control Models  
(not including DF250/225)

This system helps the boat running at a certain speed range in low RPM.

#### ADVANTAGE

- Boat can keep running at a certain speed range in low RPM without having to operate the throttle on the boat.
- Gives you precise control at low RPM.

\*Available with SMD, SMG4, or Troll Mode Switch Panel



### SUZUKI EASY START SYSTEM

▶DF40 AND UP (not including DF250/225)

Simply turn the key and release, and the starter stays engaged until the engine starts. This system offers a smoother start of the engine.



### Integrated Steering System

▶DF350AMD/300BMD

The conventional external hydraulic cylinder is built into the outboard motor.

#### ADVANTAGE

- Simple appearance of the motorwell when rigging.
- Allows rigging to various types of boats.
- Easy rigging.

## Ecology & Economy



### BATTERY-LESS ELECTRONIC FUEL INJECTION

▶DF30A/25A ▶DF20A/15A/9.9B

This technology delivers quicker start, smoother operation, and more acceleration without a battery.

#### ADVANTAGE

- Operates without battery.
- Quick and easy start.
- Cleaner and economic fuel consumption.
- Higher and smoother performance in almost all operating ranges.



### DUAL INJECTOR

▶DF350AMD/300BMD ▶DF350A/300B

The dual injectors deliver just the right amount of fuel at just the right time into each cylinder.

#### ADVANTAGE

- Contributes to higher output and better fuel efficiency.



### LEAN BURN CONTROL SYSTEM

LEAN BURN

▶DF9.9B AND UP  
(not including DF250/225)

The Lean Burn Control System supplies the appropriate amount of fuel and air mixture depending on the navigation conditions.

#### ADVANTAGE

- Significant improvement in fuel economy in all speed ranges especially at cruising speed.
- Fuel is saved and gasoline costs are lowered.

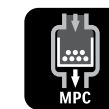

### Micro-Plastic Collecting Device

▶DF140BG/115BG ▶DF140B/115B

As one of the actions in SUZUKI CLEAN OCEAN PROJECT, we developed the device to collect micro-plastics in the oceans just by running a SUZUKI's outboard motor.

#### ADVANTAGE

- Collect micro-plastics through your outboard motors.
- No sacrifice to the engine performance.



**SHINOBI: STEALTH (In Japanese)**

The “ONE” who is quiet in nature yet strong in performance with exceptional endurance. Suzuki outboards have always been described in these terms, and finally our engines outward appearance reflects these standards of our legendary lineup of engines.

The bold new *STEALTH LINE* of engines matches Suzuki Marine’s legendary power, performance, and *Ultimate* technology. Defined style lines and the new matte black finish exudes confidence, saying “This one’s got the Look”.

- Distinctive Matte Black Finish
- Chrome Black Graphics
- Uncompromising Performance
- The *Ultimate* Look

This new lineup solidifies Suzuki Marine as the *Ultimate* Outboard Motor.

**STEALTH LINE™**

# STEALTH LINE OUTBOARD MOTORS **NEW**

DF250A STEALTH / DF250 STEALTH / DF200 STEALTH / DF150 STEALTH / DF115B STEALTH

THE **ULTIMATE**  
OUTBOARD MOTOR



## DF250A STEALTH

### STANDARD FEATURES



### ADDITIONAL FEATURES FOR DRIVE BY WIRE MODEL

#### Durability & Reliability

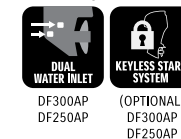

#### Ease & Comfort

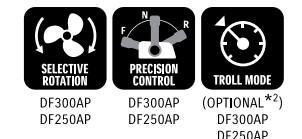

#### Ecology & Economy



## DF115B STEALTH

### STANDARD FEATURES



## **NEW** DF200 STEALTH **NEW** DF150 STEALTH

### STANDARD FEATURES



## DF250 **NEW** STEALTH

### STANDARD FEATURES

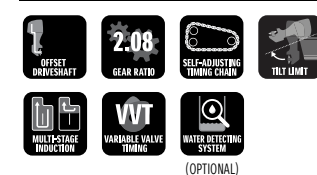

SPECIFICATIONS / FEATURES P37

\*1 Available with SMD or SMG \*2 Available with SMD, SMG, or Troll Mode Switch Panel

# V6 350-300HP Flagship - GEKI Series

◆ Drive By Wire DF350AMD / DF300BMD / DF350A / DF300B

THE **ULTIMATE**  
OUTBOARD MOTOR



## SUZUKI DUAL LOUVER SYSTEM

Dual Louver system is designed to remove water from the air taken into the cowl.

Incorporating a direct intake system makes the highest compression ratio of 12.0:1(DF350AMD,DF350A), 10.5:1(DF300BMD, 300B) possible, ultimately leading to a higher engine output.



## DUAL WATER INLET

The engine's cooling system relies on water supplied through low water intakes located on the lower unit. This dual water inlet configuration increases water flow into the lower unit, delivering greater cooling efficiency.



## SUZUKI DUAL PROP SYSTEM

The dual prop system efficiently transmits the horsepower into propulsion. As an added benefit, because each propeller rotates in the opposite direction, exceptional stability is achieved.

In addition, the contra-rotating propellers produce a strong reverse thrust.



## DUAL INJECTOR

Dual injectors deliver just the right amount of fuel at just the right time into the cylinder.

This dual injector contributes to higher output and better fuel efficiency.



DRIVE BY WIRE



DF350AMD

DF300BMD



DF350A

DF300B

# DF350AMD/ DF300BMD

# DF350A/ DF300B



## GEKI: PARTING SEAS

A Force to Match the Power of Nature and the Sea Representing Suzuki's Identity and Heritage. A Symbol of Our Passion and Commitment to the Ultimate in Marine Innovation.

\* "GEKI: PARTING SEAS" is the logo that represents the DF350AMD/DF300BMD, DF350A/DF300B

### Durability & Reliability

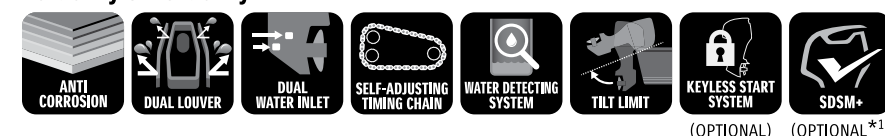

### Ecology & Economy

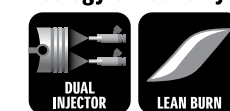

### Performance



### Ease & Comfort

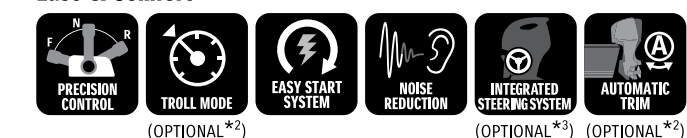

\*1 Available with SMD or SMG4

\*2 Available with SMD, SMG4, or Troll Mode Switch Panel

\*3 DF350AMD/300BMD

SPECIFICATIONS / FEATURES P36

# V6 300-225HP

- ◆ Drive By Wire DF300AP / DF250AP
- ◆ Mechanical DF250 / DF225

THE **ULTIMATE**  
OUTBOARD MOTOR

## Increased Alternator Output at Low Speed

Ideal for today's power-hungry fishing boats that spend a lot of time trolling

Applicable models : All V6 models (from 21 model year)

### ADVANTAGE

- Increased alternator output at idle and low speed.
- Enables the use of more electric pumps and equipment.

At Idling Speed (650rpm) 23A → 33A **143%**

At 1,000rpm 38A → 43A **113%**



**DF300AP  
DF250AP**

DRIVE BY WIRE



**DF250  
DF225**

MECHANICAL

### STANDARD FEATURES

#### Durability & Reliability

ALL MODELS	ALL MODELS	ALL MODELS	ALL MODELS	(OPTIONAL* <sup>1</sup> ) ALL MODELS

#### Performance

DF250 DF225	DF300AP DF250AP	ALL MODELS	DF300AP DF250AP DF225	DF250 DF225

### ADDITIONAL FEATURES FOR DRIVE BY WIRE MODEL

#### Durability & Reliability

DF300AP DF250AP	(OPTIONAL) DF300AP DF250AP

#### Ease & Comfort

DF300AP DF250AP	DF300AP DF250AP	(OPTIONAL* <sup>2</sup> ) DF300AP DF250AP	DF300AP DF250AP	(OPTIONAL* <sup>2</sup> ) DF300AP DF250AP

#### Ecology & Economy

DF300AP DF250AP

\*1 Available with SMD or SMG \*2 Available with SMD, SMG, or Troll Mode Switch Panel

# IN-LINE 4 200-150HP

- ◆ Drive By Wire DF200AP / DF175AP / DF150AP
- ◆ Mechanical DF200A / DF175A / DF150A



**DF200AP  
DF175AP/DF150AP**

DRIVE BY WIRE



**DF200A  
DF175A/DF150A**

MECHANICAL

THE **ULTIMATE**  
OUTBOARD MOTOR

## NEW SUZUKI PRECISION CONTROL (S.P.C.)

### FEATURES

Operation from the remote control is delivered to the outboard motor via an electric signal and it enables the one lever operation for up to 6 outboard motors (for dual mount only).



## SUZUKI SELECTIVE ROTATION

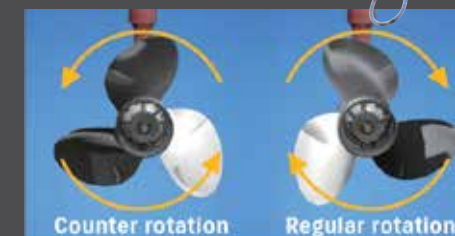

Function for selecting standard or counter rotation on one outboard with an optional connector.

## NOISE REDUCTION

Intake noise is suppressed with a resonator, that reduces sound levels and improves the boating experience.

## STANDARD FEATURES

### Durability & Reliability

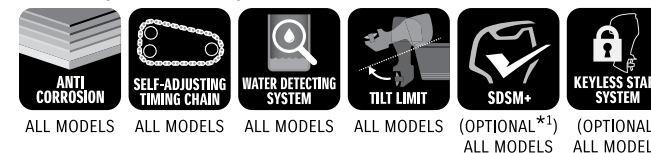

ALL MODELS ALL MODELS ALL MODELS ALL MODELS (OPTIONAL\*<sup>1</sup>) ALL MODELS (OPTIONAL) ALL MODELS

### Ease & Comfort

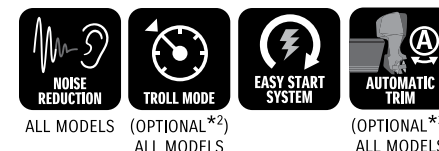

ALL MODELS (OPTIONAL\*<sup>2</sup>) ALL MODELS (OPTIONAL\*<sup>2</sup>) ALL MODELS

### Ecology & Economy



LEAN BURN  
ALL MODELS

### Performance



ALL MODELS ALL MODELS ALL MODELS Not including DF150A

## ADDITIONAL FEATURES FOR DRIVE BY WIRE MODEL

### Ease & Comfort

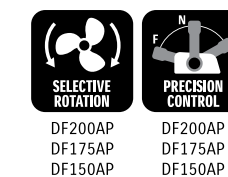

DF200AP DF175AP DF150AP DF200AP DF175AP DF150AP

\*1 Available with SMD or SMG4 \*2 Available with SMD, SMG4, or Troll Mode Switch Panel

SPECIFICATIONS / FEATURES P37

# IN-LINE 4 140-75HP

- ◆ Drive By Wire DF140BG / DF115BG
- ◆ Mechanical DF140B / DF115B / DF90A / DF75A

THE **ULTIMATE**  
OUTBOARD MOTOR



**DF140BG  
DF115BG**

DRIVE BY WIRE

with MPC

**DF140B  
DF115B**

MECHANICAL

with MPC

**DF90A  
DF75A**

MECHANICAL

■ Tiller handle model available (For 90HP & 75HP)

## COLLECT MARINE MICRO-PLASTIC WASTE

As a solution to the plastics flowing into the oceans, which are not collected properly on land, Suzuki developed the world's first Micro-Plastic Collecting (MPC) device installed on outboard motors.

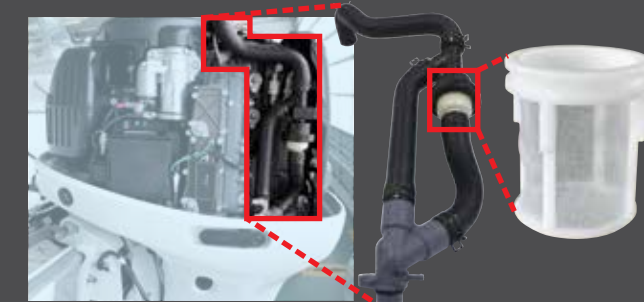

Garbage-contaminated seawater



Microplastic collector makes the sea beautiful



Collected materials

BEFORE 22 MODEL YEAR      WITH MICRO-PLASTIC COLLECTING DEVICE

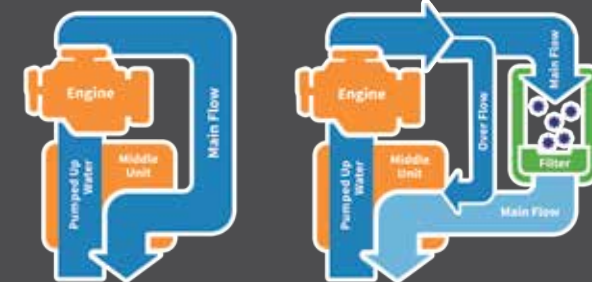

### FEATURES

- Will not affect the performance of the engine even if the filter gets clogged since this device utilizes the used cooling water.
- Will not negatively affect the environment.

### STANDARD FEATURES

#### Durability & Reliability



ANTI CORROSION  
ALL MODELS



SELF-ADJUSTING TIMING CHAIN  
ALL MODELS



WATER DETECTING SYSTEM  
ALL MODELS



TIILT LIMIT  
ALL MODELS



SDSM+  
(OPTIONAL\*)  
ALL MODELS



SUB WATER INLET  
(OPTIONAL)  
DF140BG/DF115BG  
DF140B/DF115B



KEYLESS START SYSTEM  
(OPTIONAL)  
ALL MODELS



OFFSET DRIVESHAFT  
ALL MODELS



2.59 GEAR RATIO  
ALL MODELS

#### Performance

#### Ease & Comfort



(OPTIONAL\*)  
TROLL MODE  
REMOTE CONTROL MODELS  
(STANDARD)  
TILLER HANDLE MODELS



EASY START SYSTEM  
ALL MODELS



NOISE REDUCTION  
DF140BG/DF115BG  
DF140B/DF115B



AUTOMATIC TRIM  
(OPTIONAL\*)  
DF140BG/115BG,  
DF140B/115B

#### Ecology & Economy



LEAN BURN  
ALL MODELS

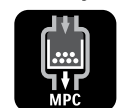

MPC  
DF140BG/DF115BG  
DF140B/DF115B

#### Ease & Comfort



PRECISION CONTROL  
DF140BG  
DF115BG

### ADDITIONAL FEATURES FOR DRIVE BY WIRE MODEL

\*1 Available with SMD or SMG4      \*2 Available with SMD, SMG4, or Troll Mode Switch Panel

# IN-LINE 3 60-25HP

DF60AV / DF50AV  
DF60A / DF50A / DF40A  
DF30A / DF25A

THE **ULTIMATE**  
OUTBOARD MOTOR



**DF60AV**  
**DF50AV**

**HIGH ENERGY ROTATION**

■ Tiller handle available

**DF60A**  
**DF50A**  
**DF40A**

■ Tiller handle available



### STANDARD FEATURES

#### Durability & Reliability

- ANTI CORROSION**  
ALL MODELS
- TILT LIMIT**  
ALL MODELS
- SELF-ADJUSTING TIMING CHAIN**  
ALL MODELS
- SUB WATER INLET**  
DF60A  
DF50A  
DF40A

- SUZUKI SDSM**  
(OPTIONAL \*1)  
ALL MODELS

#### Performance Ease & Comfort

- HIGH ENERGY ROTATION**  
DF60AV  
DF50AV
- TROLL MODE**  
(OPTIONAL \*2)  
ALL MODELS
- EASY START SYSTEM**  
ALL MODELS

#### Ecology & Economy

- LEAN BURN**  
ALL MODELS

\*1 Available with SMD or SMG4  
\*2 Available with SMD, SMG4, or Troll Mode Switch Panel

**DF30A**  
**DF25A**

**BATTERY-LESS EFI**

■ Gas assist model available  
■ Remote Control model available



### STANDARD FEATURES

#### Durability & Reliability

- ANTI CORROSION**
- SDSM+**  
(OPTIONAL \*1)  
ALL MODELS

#### Ecology & Economy

- LEAN BURN**
- BATTERY-LESS FUEL INJECTION**

\*1 Available with SMD or SMG4



### HIGH ENERGY ROTATION

These outboards are equipped with a 2.42 gear ratio, which is larger than the standard model, in their lower units. When combined with a large 36cm (14-inch) propeller, the system can deliver powerful thrust. This is ideal for heavy boats.

- ADVANTAGE**
- Powerful propulsion and precise maneuvering, even with heavy loads.
  - Superior power to turn large diameter propellers.

### DF60AV vs. DF60A size comparison

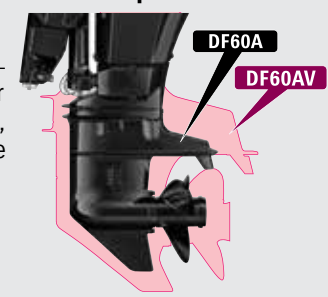

	DF60AV	DF60A
Gear Ratio	2.42	2.27



### SELF-ADJUSTING TIMING CHAIN

The timing chain running in an oil-bath is adjusted automatically by a hydraulic tensioner.

- ADVANTAGE**
- More durable than the belt type.
  - Maintenance-free.



### BATTERY-LESS Electric Fuel Injection

P11

This technology delivers quick start, smooth operation, and strong acceleration without a battery.

### TROLL MODE + SMG4

P30



Allows you to control your troll mode from the Multi-Function Gauge.

Flagshtn-GEKI SERIES  
V6 300-200HP  
IN-LINE 4 200-150HP  
IN-LINE 4 140-75HP  
IN-LINE 3 60-25HP  
PORTABLE 20-2.5HP  
STEALTH LINE

# PORTABLE 20-2.5HP

DF20A / DF15A / DF9.9B  
DF6A / DF4A  
DF2.5



**DF20A**  
**DF15A**  
**DF9.9B**

**BATTERY-LESS EFI**

■ Remote control model available

**DF6A**  
**DF4A**

**THREE-WAY STORAGE**

**DF2.5**

THE **ULTIMATE**  
OUTBOARD MOTOR



## INTEGRAL OVERHEAD FUEL TANK

The integral overhead fuel tank and one-way valve delivers fuel supply using gravity.

## THREE-WAY STORAGE



The design allows the outboard to be removed from the boat and placed on any of its 3 sides for storage.

## STANDARD FEATURES

### Durability & Reliability

- ANTI CORROSION**  
ALL MODELS
- SDSM+**  
(OPTIONAL \*1)  
DF20A  
DF15A  
DF9.9B

### Ease & Comfort

- THREE-WAY STORAGE**  
DF6A  
DF4A
- OVERHEAD TANK**  
DF6A  
DF4A

### Ecology & Economy

- LEAN BURN**  
DF20A  
DF15A  
DF9.9B
- BATTERY-LESS FUEL INJECTION**  
**LESS**  
DF20A  
DF15A  
DF9.9B

\*1 Available with SMD or SMG4

# PERFORMANCE

## SUZUKI ULTIMATE TECHNOLOGY

THE  
**ULTIMATE**  
OUTBOARD MOTOR

Sergio Davi Ventures From Italy to Los Angeles with Suzuki DF300B

### SUZUKI'S UNIQUE ENGINE STRUCTURE. OFFSET DRIVESHAFT & ADVANTAGES OF 2-STAGE REDUCTION GEAR.

#### ADVANTAGE

- High-performance outboard motors are the choice of professionals. With high gear ratios and torque, they deliver top performance even in demanding work environments.
- Less vibration.
- More compact.
- Stable steering performance.

#### GEAR RATIO IN EACH CLASS

	DF40A-DF60A	DF50AV-DF60AV	DF75A-DF90A	DF115B-DF140B	DF150A(AP)-F200A(AP)	DF225-DF250	DF250AP-DF300AP	DF300B-DF350A
GEAR RATIO	2.27	2.42	2.59	2.59	2.50	2.29	2.08	2.29
2 Stage Reduction			✓	✓	✓	✓	✓	✓

1st Stage Reduction :  
30:36=1.20

2nd Stage Reduction :  
12:25=2.08

Total : 2.50:1

**DF200A**

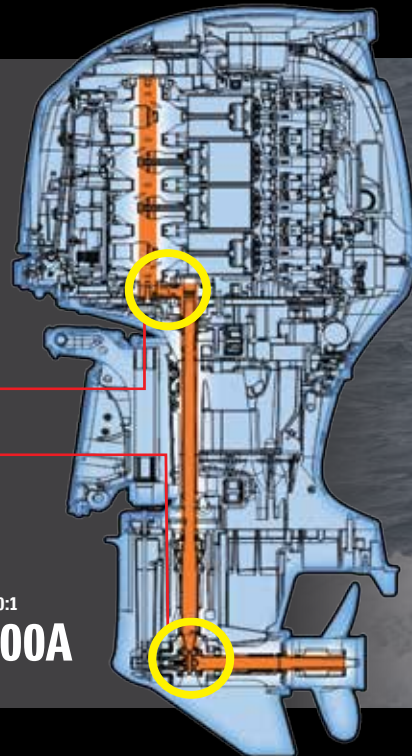

# SUZUKI ENGINES' DURABILITY WORLDWIDE

Here is the data of our customers who have used Suzuki outboard motors for a long time. These engines are actively running for long periods of time.\* We would like to express our sincere appreciation to these customers and we will continuously make our best efforts to provide the Ultimate Outboard Motor to all customers. \*As of January 2023

#### NORWAY



#### DF140A

**3,116** hours

Commercial Fishing

#### CHINA



#### DF140A

**4,291** hours

Commercial Fishing

#### JAPAN



#### DF150

**3,513** hours

Commercial Fishing

#### UAE



#### DF250 (Triple engine)

**4,633** hours

**5,851** hours

**4,632** hours

Commercial Fishing

#### THAILAND



#### DF250 (Triple engine)

**2,957** hours

**2,846** hours

**2,972** hours

Transportation

#### GUATEMALA



#### DF115

**6,163** hours

Pleasure Fishing

### Suzuki believes giving the highest priority to durability continues to make our customers happy.

This is based on the SDS (SUZUKI DIAGNOSTIC SYSTEM) and SDSM (SUZUKI DIAGNOSTIC SYSTEM MOBILE) data that has been received at periodic maintenance.

- Results will vary depending upon operating conditions (boats type, size, weight [load], weather).
- The above figures are measured values.
- The above figures show the operation hours of engines at the latest periodic maintenance.

## User voice

Here you can find Suzuki outboard motor users enjoying the ULTIMATE PERFORMANCE. Suzuki outboard motors play an essential role for the users engaging in professional work.

[https://www.youtube.com/@SuzukiGlobal\\_official/videos](https://www.youtube.com/@SuzukiGlobal_official/videos)



## SUZUKI MULTI-FUNCTION GAUGE (SMG4) ▶DF9.9B AND UP

Suzuki Multi-Function Gauge provides all performance information on one gauge. Individual elements can also be emphasized to further enhance user friendliness.

SMG4



DAY MODE



NIGHT MODE

FEATURES



MULTI-LINGUAL MENU



AUTOMATIC TRIM FUNCTION

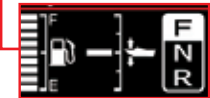

Automatically adjusts trim angle.

ANALOG TACHO & SPEED MODE

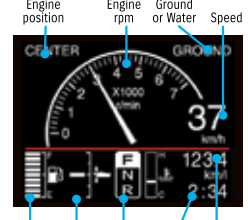

TROLL MODE



SPECIFICATIONS

- 3.5 Color Display
- Size: 4.13 in. (W) x 4.13 in. (H) x 0.63 in. (D)
- NMEA2000 output
- Shows both digital and analog readouts, as well as day/night mode
- Displays the QR code\* for SDSM / SDSM+
- Troll Mode Function: Allows user to control troll mode (only for 2019MY and newer models adapted to troll mode)

English, French, Italian, German, Spanish, Swedish, Norwegian, Finnish, Dutch, Portuguese, Danish, Russian, Japanese

\* DENSO WAVE owns the rights of the name and the logo of QR code.

## FURUNO FishHunter™ Drive

FishHunter™ Drive delivers all-new control features for boaters utilizing select Suzuki outboard models driven by the Furuno NAVpilot-300 Autopilot. these unique Suzuki features include Speed Control, Point Lock™, Route Smoothing™, and Sabiki Lock™.



NAVpilot  
NAVpilot-300

Applicable Models : All SPC models (DF350AMD/300BMD, DF350A/300B, DF300AP/250AP, DF200AP/175AP/DF150AP, DF140BG/115BG)

## WATERGRIP PROPELLER

WATERGRIP is a stainless-steel propeller series offering accurate response to your operation. With this propeller series efficiently converts engine power into propulsion, and meets our customers' demand for bigger, faster, more powerful outboards.

The WATERGRIP propeller series employs a new interchangeable and square shaped propeller bushing that minimizes power loss in delivery.

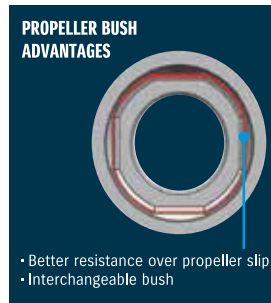

- Better resistance over propeller slip
- Interchangeable bush



## MULTI-FUNCTION TILLER HANDLE ▶DF115B ▶DF75A/90A ▶DF60A/50AV/60AV ▶DF40A/50A

Main features



Tachometer\* with warning indicators



Three-position angle adjustable bracket



Troll mode switch\*  
• Activates SUZUKI Troll Mode System and controls RPM from idling engine speed up to 1200rpm at every 50rpm.



Power trim & tilt switch\* and throttle grip friction adjuster

## SUZUKI PRECISION CONTROL FOR DRIVE-BY-WIRE SYSTEM

▶DF350AMD/300BMD ▶DF350A/300B ▶DF300AP/250AP ▶DF200AP/175AP/150AP ▶DF140BG/115BG ▶DF250ASTEALTH

Suzuki's best technology lies in the Suzuki Precision Control (S.P.C.) for Drive-By-Wire System. The S.P.C. enables instant, precise throttle response for greater control and accuracy.

FEATURES

- Control up to 6 outboard engines.
- Sequential start for multi-engine boats: Engines start in order from port to starboard.
- Automatic Trim is available with SMD or SMG4.
- 1 Lever Operation : This switch allows multiple engine operation with just 1 lever. (Dual top mount only)
- Integrated Emergency Switch (Flush Mount only)

REMOTE CONTROL BOX

Integrated "Select" and "Throttle Only" switch (All)



SUZUKI BINNACLE

DUAL BINNACLE

FLUSH MOUNT BINNACLE

CONTROL PANEL



SWITCH PANEL FOR REGULAR KEY



## KEYLESS START SYSTEM\*

▶All S.P.C. models and DF200A/175A/150A ,DF140B/115B, DF90A/70A

DESIGN

How to use

1. Stand nearby the console with the key fob.
2. Push START/STOP button to start engine.
3. To turn off the engine, push the button again.

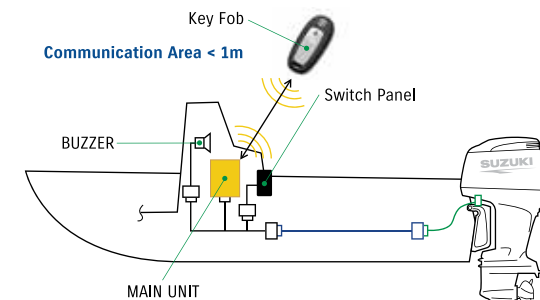

Find out more by watching our videos

\*Please check applicability with your local Suzuki dealer.

FEATURES

- 3 types of panels are available: Vertical, Horizontal and Individual.
- 1-push Start/Stop, and controls up to 6 engines. No ignition key necessary.



Find out more from our video

## MAINTENANCE KITS

Suzuki provides maintenance kits for quick and reliable service. Each kit comes with all the specific maintenance parts necessary for your model.



Please consult your local Suzuki dealer for the contents of each kit and applicable models.



# PARTS & ACCESSORIES

## SUZUKI DIAGNOSTIC SYSTEM MOBILE PLUS (SDSM+)

DF9.9B AND UP

\*Available with SMD or SMG4

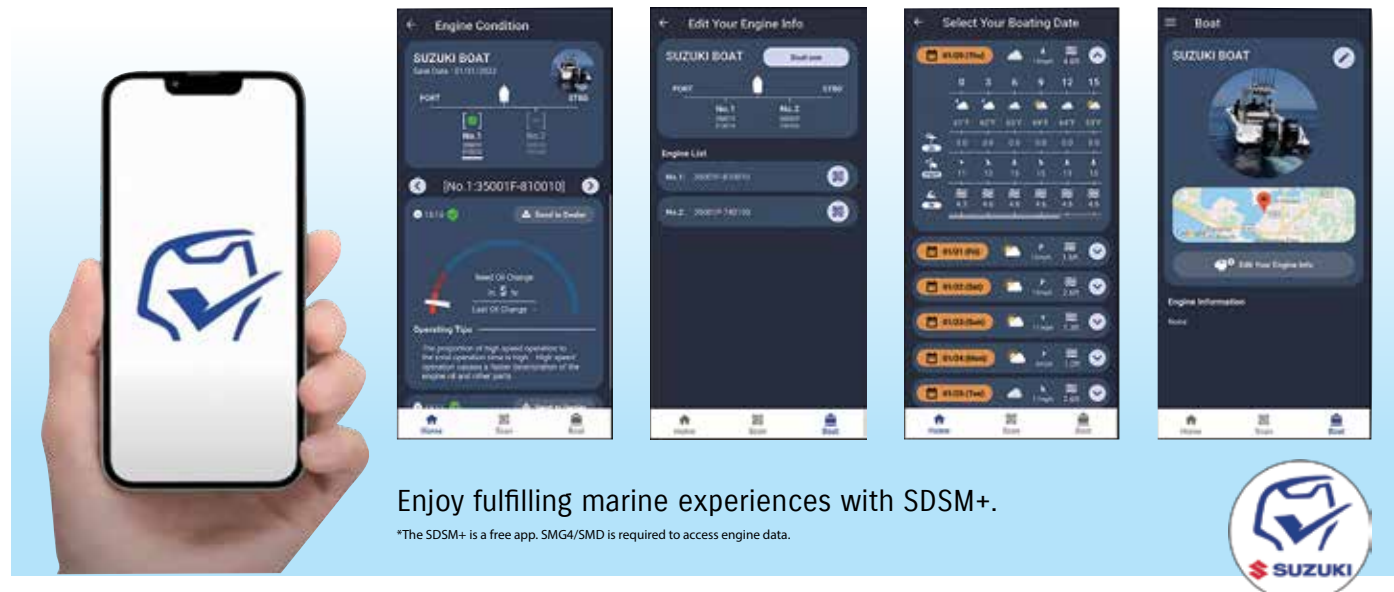

Enjoy fulfilling marine experiences with SDSM+.

\*The SDSM+ is a free app. SMG4/SMD is required to access engine data.



### 3 FEATURES OF THE SDSM+

#### 1. PLAN A BOAT TRIP WITH THE FORECAST

- + You can make a boating plan and refer to the weather, wind, and wave condition at a designated point.
- + The app also shows the weekly weather forecast, which is constantly updated.

#### 2. INSPECT BOAT AND OUTBOARD MOTOR IN ADVANCE

- + Outboard motor can be checked based on the engine data.
- + You can share engine data with your dealer, which can shorten the service time.

#### 3. ACQUIRE ENGINE DATA

- + You can check the engine condition and your driving tendencies.
- + You can provide engine data to your dealer, to check engine maintenance reminders.



Apple and the Apple logo are trademarks of Apple Inc., registered in the U.S. and other countries. App Store is a service mark of Apple Inc., registered in the U.S. and other countries.

Google Play and the Google Play logo are trademarks of Google LLC.

### HOW TO GET THE ENGINE DATA

1. The outboard will convert engine data into a QR code\* displayed on the SMG4 or SMD.
2. Open the app and scan the QR code. The app will receive the engine data and automatically attach it to an e-mail.
3. You can then send the e-mail to your nearby dealer to shorten the maintenance time.



\*DENSO WAVE owns the rights of the name and the logo of QR code.

Find out more at our Global Website

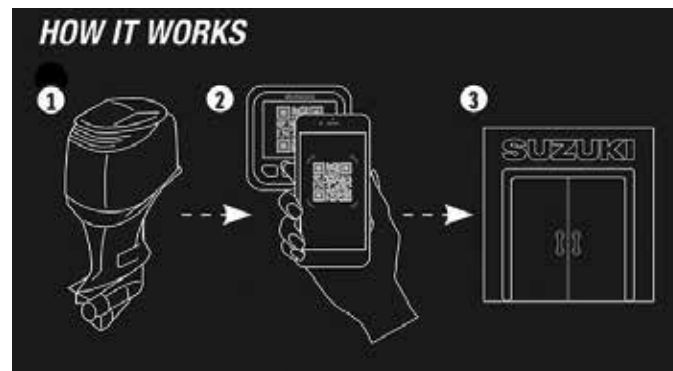

# ECSTAR

GENUINE OIL & CHEMICAL

## What is ECSTAR

ECSTAR is a global brand name of SUZUKI Genuine Oil & Chemicals.

## The ULTIMATE Formulation

Suzuki Approved Genuine engine oils have all been rigorously tested and certified by Suzuki engineers. You can be confident that they'll help keep your Suzuki outboard in perfect condition, giving you maximum performance and reliability over its lifetime.



## ECSTAR Line up for OUTBOARD MOTOR



Availability may differ in some regions. Please contact your Suzuki local dealer.

## Integrated Control System

"SYNCRO-EYE" is a comprehensive system

Suzuki has developed which "connects" various devices that work together in synchronization. This innovative system

will help improve the control technology of the vessel by "sensing" various situations and will also be compatible with future technologies.



# HISTORY

THE  
**ULTIMATE**  
OUTBOARD MOTOR

Continuously evolving over the decades, Suzuki has a rich, proud history knowing no bounds.

## SUZUKI A HISTORY OF OUTBOARD INNOVATION

**1965**  
**D55**  
SUZUKI'S FIRST OUTBOARD MOTOR  
*Yamamika Spirit*  
*"Let's give it a try."*

**1974**  
EARLY OIL INJECTION ENGINES  
**DT25**

**1980**  
**DT85**

**1987**  
WINNER NMMA MOST INNOVATIVE PRODUCT AWARD  
**DT200 EXANTE**

**1997**  
**DF70**  
INDUSTRY-FIRST 4-STROKE WITH EFI  
NMMA INNOVATION AWARD WINNER

**2006**  
INDUSTRY-FIRST V6 300 HP 4-STROKE  
NMMA INNOVATION AWARD WINNER  
**DF300**

**2008**  
**DF90/70**  
INTRODUCTION OF OUR INNOVATIVE LEAN BURN CONTROL SYSTEM

**2014**  
DF200 ADOPTS SUZUKI SELECTIVE ROTATION AND DELIVERS BIG BLOCK PERFORMANCE FROM AN INLINE 4 ENGINE  
**DF200AP**

**2017**  
**DF350A**  
FIRST OUTBOARD CONTRA-ROTATIONAL DUAL PROP SYSTEM  
NMMA INNOVATION AWARD WINNER

**2020**  
DF115/140BG FIRST IN HP CLASS ALL-DIGITAL ENGINES  
SELECTED BOATING INDUSTRY TOP PRODUCTS 2021  
**DF115/140BG**







Please read your Owner's Manual carefully. Remember, boating and alcohol or other drugs don't mix. Always wear a personal flotation device when boating. Please operate your outboard safely and responsibly.

Suzuki encourages you to operate your boat safely and with respect for the marine environment.

Specifications, appearances, equipment, colors, materials and other items of "SUZUKI" products shown in this catalogue are subject to change by manufacturers at any time without notice and they may vary depending on local conditions or requirements. Each model might be discontinued without notice. Please enquire at your local dealer for details of any such changes. Actual body color might differ from the colors in this brochure.



**Suzuki Marine USA, LLC**  
13521 Prestige Pl.  
Tampa, FL 33685-2529  
www.suzukimarine.com

FULL LINE CATALOG  
99953-24501  
Printed in the U.S.A.

©2024 Suzuki Marine USA, LLC. All rights reserved.



suzukimarine.com